



Preface

Thank you for selecting our products. We will offer the best service for you wholeheartedly.

We take DVR5216-A as a sample. In this series, different product models' configuration will have a little difference, and it will work the difference between product function and operation.

It is for reference only. We will not provide any new information separately for later firmware update. The updating files will be added into the new edition of the user manual. This user manual may have some inaccuracy or misprint. We sincerely hope your timely feedback and comments to let us correct and improve this booklet in the subsequent edition.

CONTENT

Preface 1

Chapter1 Brief Introduction about the DVR 6

 1.1 Summarization 6

Chapter2 Technology Guideline and Main Functions 6

 2.1 Technology Guideline 6

 2.2 Main Functions 8

Chapter3 Equipment Installation and Illustration 12

 3.1 Installation Environment and Cautions 12

 3.1.1 Attentions on Installing Hard Disk 13

 3.2 Package Checking 13

 3.3 Device Interface 14

 3.3.1 Audio/Video Connection 14

 3.3.2 USB Backup Interface 14

 3.3.3 Network Interface 14

 3.3.4 Alarm Input/Output Connection 14

 3.3.5 RS-485 Connection 18



3.3.6 Keyboard Controlling	19
3.3.7 Intercommunication Port	19
3.4 Front Panel Description	20
3.5 IR Remote Controller Operation	23
3.6 Mouse Operation	25
3.7 Menu Operation Description	27
3.7.1 Menu Structure Chart	27
3.7.2 Menu Option Schedule	28
Chapter4 Device Operation	34
4.1 การใช้ งานพื้นฐาน	34
4.1.1 ล็อก/ปลดล็อกเครื่อง	34
4.1.2 ลงชื่อใช้งานเข้าระบบ.....	34
4.1.3 การล็อกเครื่อง	35
4.1.4 เมนูหลัก	35
4.1.5 แถบสถานะ	36
4.1.6 ช่องต่อจอ	36
4.2 ตัวช่วยเมื่อเริ่มใช้งาน	37
4.3 เรียกดูวิดีโอและเล่นย้อนหลัง Data Inquiry and Playback	38
4.3.1 ค้นหาตามช่วงตามเวลาTime Inquiry	38
4.3.2 ค้นหาตามเหตุการณ์Event Inquiry	38
4.3.3 จัดการข้อมูลData Management	42
4.4 Backup Management	42
4.4.1 Quick Backup	43

|||| User Manual

4.4.2 Manual Backup	43
4.4.3 Schedule Backup	43
4.5 Record Setup	44
4.5.1 Record Parameter	44
4.5.2 Screenshots Parameter	45
4.5.3 Manual Record	45
4.5.4 Manual Snapshot	46
4.5.5 Schedule Record	46
4.6 Alarm Setup	47
4.6.1 Motion	47
4.6.2 Sensor	48
4.6.3 Alarm Output	49
4.6.4 Other Alarms	50
4.6.5 Manual Alarm	50
4.7 System Setup	51
4.7.1 General Setting	51
4.7.2 Time Setting	52
4.7.3 Output Setting	53
4.7.4 COM Setting	56
4.7.5 PTZ Setting	57
4.7.6 Network Setting	61
4.8 HDD Management	70
4.8.1 Basic Information	70
4.8.2 HDD Group	71



4.8.3 Storage Setting	72
4.8.4 SMART	73
4.9 Information Inquiry	73
4.9.1 System Information	74
4.9.2 Record Status	74
4.9.3 Alarm Status	75
4.9.4 Online Status	75
4.9.5 Log Inquiry	76
4.9.6 Input State	76
4.10 System Maintenance	77
4.10.1 Quick Settings	77
4.10.2 User Management	77
4.10.3 Restore Defaults	78
4.10.4 Upgrade Management	79
4.10.5 Auto Reboot	81
4.11 Logout/Shutdown/Reboot	82
4.12 Password Reset	82
4.13 Power Resume	82
Appendix 1: IE Operation Instructions	83
1. LAN Configuration for IE Browse	83
2. WAN Operation Instructions	84
Appendix 2: Net DVR Q&A	87

Chapter 1 Brief Introduction about the DVR

1.1 Summarization

This device is designed for HD analogue Audio&Video monitoring system . They are adopting H.264 compress format, integrate the embedded RTOS and processor to realize all of the functions like video and audio acquisition and compression, storing, remote control, Multi-PTZ control and alarm in a single board. This series DVR achieve the integrate host to a single plate structure, which ensure the system's high-integration and reliability.

This series of equipment use private file systems MFS V2.0, namely flow media file system second edition. This file system is based on Microsoft FAT32 to innovate, suitable for DVR special file system, support more than 2TB hard disk; Long time operation does not produce disk fragments; Reasonable flow media operation scheduling, the operation has fast response; Increase check protection in the MFS key information, avoid key areas damaged cause to catastrophic problem.

This device can be the local independent work, also can build a strong safety monitoring system by network. Can be applied to Banks, telecommunications, electric power, transportation, intelligent community, factory, warehouse, etc.

Chapter 2 Technology Guideline and Main Functions

2.1 Technology Guideline

1. Video parameters (Series devices support different video source types, specific please according to the model to decide.)
Video input: HD analogue video input 720p/25HZ, 720p/30HZ, 720p/50HZ, 720p/60HZ (BNC interface, 1Vp-p, 75 Ω)
Video output: HDMI*1/VGA*1



2. Audio parameters

Analog audio input: RCA interface port, input resistance: $10K\Omega$, input extent: $V_{p-p}=2.0V$ LINE

Audio output: RCA interface, input resistance: $10K\Omega$, input extent: $V_{p-p}=2.0V$ LINE

Voice chat: Input multiplexes with 1st audio input channel, (RCA interface port, input resistance: $10K\Omega$, input extent: $V_{p-p}=2.0V$ LINE)

3. Video compression: Compression arithmetic H.264, support the maximum resolution 720p: 1280*720 30 fps/ch

4. Audio compression: Compression arithmetic G.711A, Audio sampling rate 8K sample/sec., 16 bit/sample

5. Code stream type: VBR/CBR

6. Operation System: Linux

7. HDD interface: support 48bit LBA working mode

8. Alarm interface

Alarm input: Alarm input support normal on/off

Alarm output: Normal on, relay output

9. Serial interface: Support RS485 (half-duplex/full-duplex), support network transparent connection, support serial keyboard

10. Operation method: Multi-function IR remote control (Can also control though Front-panel), USB mouse, COM keyboard

11. Backup interface: USB2.0 interface

12. Network port: RJ45 10M/100M/1000M Ethernet Interface

13. Power supply: $220 \pm 30\%$ V, $50 \pm 3\%$ HZ, $110 \pm 20\%$ V, $60 \pm 3\%$ HZ

|||| User Manual

2.2 Main Functions

High effective RTOS and embedded processor are adopted in this series DVR, as well as all functions needed for the monitoring system are integrated. Code is solidified in the flash chip to keep the system in high stability and reliability. System can also work in a long time surveillance environment and even in stringent circumstance.

注意: The following features might differ from the below description since we have series products and different hardware and software versions. Some series devices don't support CVBS output, WLAN settings etc, please refer to actual interface.

◆ Compression features

1. Support PAL/NTSC video format signal.
2. Video compression algorithm is H.264.
3. Video and audio signals are compressed into H.264 code stream. Audio and video stream are synchronous when playback, and audio recording can be canceled if only video is in need.
4. Audio compression algorithm adopts G.711A, and every audio/video signal is compressed separately in real time, then generate composite compressed code stream. The video and audio stream are synchronous when playback, or setting disable audio with the sampling rate of 8K sample/sec., 16 bit/sample.
5. Supporting dual stream compression: main code stream used for local storing, sub code stream used for image transmission in low-bandwidth network.
6. 6 levels of record quality is available to select. Users can choose according to requirements so that the recording time is long enough.

◆ Recording function

1. Support 4 record modes: manual, schedule, motion and alarm recording.
2. Support 5 screenshot modes: manual screenshot; manual, schedule, motion and alarm snapshot.
3. Video motion detection function: multi detection areas can be set up to 5 sensitive levels.
4. Support screen shield. Each channel can max setting 4 mask areas, support preview mask, record mask and all mask.
5. Each channel support 4 interested area setting.
6. Support sensor alarm. One sensor can be linked to one or more cameras. Support alarm recall to PTZ preset point.
7. Monitoring center can record the real time compression code stream, and support synchronizing record video and audio into client PC.
8. Video and audio parameters of each camera can be set up separately.
9. Support channel title and recording time superpose.



10. Support multiplex operation, can real time recording without impacting other functions. (such as playback, fast forward, slow playback, rewind, network monitor, VOD and remote)

11. Support pre-record feature, and pre-record time is 5-30 seconds.

12. Support record status inquiry function.

◆ Playback function

1. Support inquiry recording files/pictures by time, fix position by time to record/pictures playback.

2. Support inquiry recording files/pictures by event, as per channel number/record type to inquiry/record/pictures playback.

3. Support intuitive video information graphical display and play.

4. Support zoom in on playback.

5. Support quick playback.

6. Support inquiry other time/channel recording files through list to playback.

7. Support Multi-graphic format and multi-channel selection when replaying.

8. Support video data checking and Graphic format displaying when in replay. Can also support replay by rime shaft.

9. Support replay in DAT, AVI format.

◆ Real time surveillance features

1. Support HDMI, VGA, dual output with source.

2. Support max resolution to 1080p.

3. Support 1/4/8/9/16 ch preview, the order of channels can be adjusted and the time position in preview also adjustable.

4. Support 24Hour/12Hour mode switching.

5. Support DST.

6. Support zoom in.

7. Support mask some parts of area or all.

8. Support adjust video parameter (scene setup, brightness, contrast, saturation, hue, NR) for each channel.

9. Support cruise.

10. Support intercom.

11. Support a variety of mainstream PTZ decoders control protocol, support preset point, PTZ preset point cruise and trajectory cruise.

|||| User Manual

◆ Storing and backup function

1. Max Storage:SATA*2, detailed storage depends on device model
2. Support data lock/unlock/delete for all recording files/pictures.
3. The maximum saving time of recording files/pictures can be set, the DVR will auto delete the data which exceed the setting time.
4. Support set read-only/read-write to HDD.
5. Support HDD grouping, assign different capacity to different channel.
6. Support backup data by USB interface mobile drive
7. Support batch backup as per files.
8. Support clipping and backup when record playback (local HDD).
9. Support log backup.
10. Support backup record files by IE browser.
11. Powerful hard disk management function, support HDD dormancy and format, support the damaged partition shield, bad disk to eliminate and alarm mechanism.

◆ Alarm inspection function

1. Local alarm:manual alarm,video lost alarm, motion detection alarm, sensor alarm,HDD faulty alarm,temperature alarm,network disconnect alarm,video shield alarm,disk full alarm.
2. Video lost alarm, motion detection alarm, sensor detection alarm response on time.
3. Network alarm linkage (upload alarm signal), sound alarm through the PC own horn.
4. Support continuous alarm when motion detection, every channel can set several detection area.
5. Support upload alarm information by email, send alarm channel/type/pictures to the assigned email.
6. Support motion detection and sensor detection jump to PTZ preset point.

◆ Network function

1. Support TCP/IP protocol (support ARP, RARP, IP, TCP, PPPOE, DHCP, DDNS).
2. Support 3G and ADSL dial-up network connection, and support auto-redial after disconnect.
3. Perfect network-end control order (Client manager and IE browse can be used to control the DVR, such as setting the parameters, remote upgrade, etc).



4. Support composite channel preview through IE browser.
5. Support control PTZ/lens/wiper by network.
6. Firmware upgrade through network makes after sale service much easier.
7. Support FTP upgrade.
8. Support NTP timing.
9. Support DDNS.
10. Support IP Server and can connect the platform automatically.
11. Support Global network plug and play, FTP video upload.
12. Support alarm upload by email (video lost, motion detection, alarm detection, disk full).
13. Support mobile phone surveillance.
14. Support email test and DDNS test.

◆ Security guarantee

1. High quality 32 bits embedded microprocessor and embedded RTOS, which ensure the system's high-effectivity, reliability and stability.
2. Perfect log search function.
(such as sensor record log, motion detection record log, remote login log, record parameter modification log, update log, playback log, system start-up log, backup log)
3. System lock, keystroke lock, password verification, multi-level user authorization (using the username and password as encryption key of code stream when transmission).
4. Video lost alarm, motion detection alarm and sensor alarm can be informed by email.
5. Network alarm linkage (alarm signal can be uploaded).
6. Watchdog function. When the system is abnormal, watchdog automatically detects and reboots the system.

◆ Exploitation support

Client manager software and client management SDK.

Chapter 3 Equipment Installation and Illustration

3.1 Installation Environment and Cautions



Installation environment:

- Normal working temperature is -10°C-55°C. Storage temperature is -10°C-70°C.
- Normal working humidity is 15%-85%.
- The equipment must keep horizontal either in installation or on using.
- Avoid installing in high temperature or humidity conditions.
- Heat release fans are placed for cool down, so you should put the device on ventilated place.
- The back of Net DVR should be placed 6cm away from the other device or wall while installing.
- Moving the Net DVR between two places with high difference in temperature will shorten the using life.
- Please install the lightning conductor when the machine is used in frequent thunder areas.
- The HDMI cable must be with magnetic ring.



Cautions:

- Don't touch the power switch or the Net DVR by wet hands.
- Make sure the machine and its case are grounded (There is an earth interface on the back panel of the machine).
- Keep the power supplier stable to avoid abnormal power cut off.
- Avoid dropping liquid or metal into machine that may cause short circuit or fire.
- Don't record or playback until at least one HDD is installed.
- Short circuit would happen when moist dust is on the board, so user has to termly brush the board and other accessories to make the machine work in good condition.



- Video/audio/RS485 devices can't be plug or draw when the power is on, or else the equipment will be easily damaged.
- Use the power on/off button on the front panel instead of direct shut off the power directly when turn off the Net DVR, so that the hard disk won't be damaged.
- After installation, machine can automatically detect hard disk. If an unformatted hard disk is detected, system will give off information whether to format the disk (the dvr support format HDD, don't need operate in PC).
- Warning: Don't try to plug in HDD to PC if not specialized persons, the following operation of HDD on PC will cause HDD can't be recognized and need format when plug in at next time:1,modify or edit the file name. 2,open the file and edit the content. 3,copy back the data which copied out before to HDD again. 4,Some third party browser software will also change HDD physical storage location in the background.
- Don't open the cover before power off.
- In order to ensure the integrity of the video data, if found that HDD was damaged please promptly replaced (log has the record of HDD faulty).

3.1.1 Attentions on Installing Hard Disk

1. Recommend high speed hard disk above 7200 rpm.
2. The capacity of the single hard disk is above 32GB at least, each HDD can max support 4TB.
3. The selection and calculation for capacity:

Total capacity= channels number * record time needed (hours) * capacity per hour (M/hour)

For example: If you choose the recording bit rate type for CBR 4Mb (refer to 4.3 for bit rate types), the HDD Capacity /hour/channel=bit rate(Mbps) * 3600s=4Mbps*3600s=14400Mb, because 1MB=8Mb, so the data capacity of each channel/hour when choose CBR 4Mb is 14400Mb/8=1800MB.

Due to the various factors, the calculated result is for reference only. Some slight differences or small errors might exist in the calculation.

Audio recording capacity is about 30MB per camera per hour. In order to save HDD space, we suggest closing the audio except users mandatory require audio recording.

Notes: When HDD is full, the default set will let system overwrite the earliest 1 day recorded files, please consider this situation when calculate the HDD capacity.

4. The attachments, such as data cable, power line, and hard disk are prepared well.

Notes: This series DVR don't support the hot swap, please install the HDD and connect the data line first then plug the electricity in.

3.2 Package Checking

After open the box, please check the DVR whether was distorted or damaged. If there have, please do not use it and contact your suppliers in time. Meanwhile, please check all accessories of the DVR; do read the attached information carefully. (Notes: Accessories as for the packing list)

|||| User Manual

3.3 Device Interface

3.3.1 Audio/Video Connection

Video output: 1 VGA output, 1 HDMI output,

Audio output cautions: connect sound box or RCA output.

3.3.2 USB Backup Interface

The U disk for backup should be FAT32 format. If you want to format the U disk, please enter the “HDD Management” to check it. (Specific operation please refer to “HDD Management”) The U disk backup operation please refer to “Backup Operation”.

3.3.3 Network Interface

There is a RJ45 10M/100M/1000M adaptive Ethernet interface which is used to connect the PC and the DVR.

The indicator lights ACT and LINK are used to indicate current network status.

LINK (Network speed indicator) green—1000M orange—100M off—10M

หมายเหตุ: Some devices provide 1 RJ45 10M/100M ethernet port, the green light on--100M off--10M

ACT (Send/Receive data indicator) Blink—Sending/Receiving data

3.3.4 Alarm Input/Output Connection

Because different model use the different alarm in/out type, so please refer to the corresponding way to connect.

(1) 2 segment alarm type

Alarm input: input impedance is $22K\Omega$, window comparison voltage is 0-0.8V.

(Explanation: test the voltage between GND and alarm input, if the value at 0v-0.8v, the host will not alarm, if the voltage over than 0.8V, the host will alarm)

Alarm output: relay (120VAC/1A, 24VDC/1A), Normal (relay on), alarm (relay off)

(2) 3 segment alarm type

Alarm input: Input resistance: $22K\Omega$, window contrast voltage (3.0V-4.18V).

หมายเหตุ: There will be alarm when the voltage between 0V-3V or 4.18V-12V, and no alarm when the voltage between 3.0V-4.18V)

Alarm output: Relay (240VAC/7A, 125VAC/10A, 28VDC/10A), normal (relay open), alarm output (relay close).
Sensor power: The machine provides a +12V DC power output port.

Introduce the 3 segment alarm connection as below, the difference between 2 segment alarm and 3 segment alarm is don't need add resistance when use 2 segment alarm type.
1. Alarm sensor connection:

Alarm input: The physical connections of the normal on/off mode are the same. And user can select normal on/off mode in the DVR.

หมายเหตุ: The alarm input port which haven't used should be closed in the DVR.

Typical alarm connection: the sensor power supply is provided by DVR. The fig is as follows:

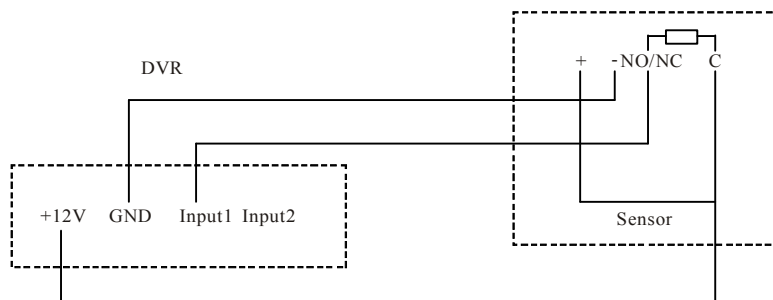

|||| User Manual

If the distance between the probe and DVR is too far, the probe requires a separate power supply:

Please connect 2 side to ground if conditional when use separate power, otherwise long distance transmission maybe make false alarm.

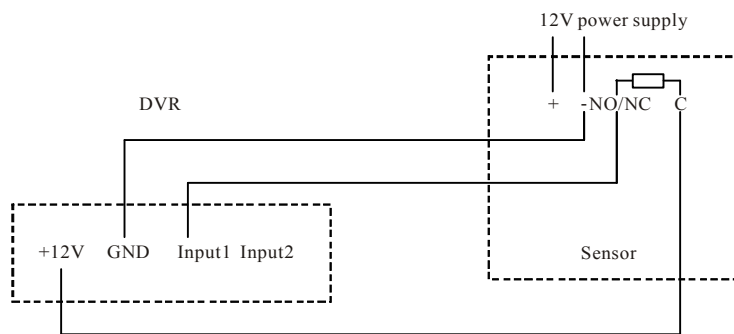

If we parallel connected the sensor, the DVR can not recognize the triggered sensor. User need to have a resistance.

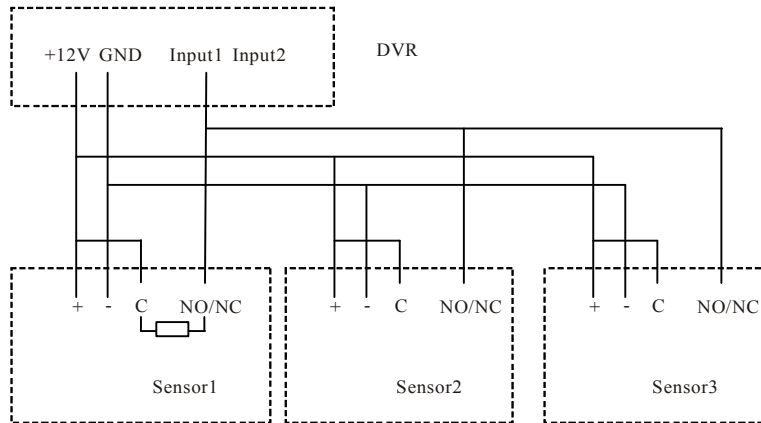

2. Alarm output connection:

The alarm output side is normal-off and do not have voltage output. The other alarm equipments (loudspeaker, light, alertor) need the individual power supply.

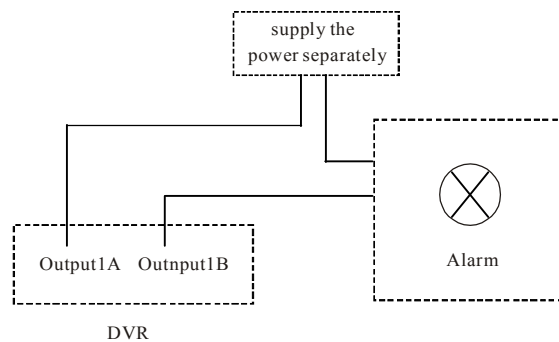

Normally, Alarm's power usually is much bigger, preferably supply power separately, and do not use the DVR's power to supply. Each series alarm output critical parameters are as follows: 240V/AC7A, 125V/AC10A, 28V/DC10A. Exceeding these parameters will damage the motherboard.
注意: The power of external alarm device should be limited as 120V/AC 1A, 24V/DC 1A when use 2 segment alarm.

3.3.5 RS-485 Connection

Attentions for PTZ decoder connection:

1. Confirm that the PTZ decoder and Net DVR are one point ground connected, or common mode voltage might exist to cause the PTZ invalid.
2. Prevent high voltage inroad, carefully dispose connection cables secure thunder proof.

RS485 support half-duplex , specific operation method is as follows:

Choose "RS485 Half-duplex" in "COM" interface, the RS485 signal lines T/R+, T/R- support one-way send and receiving, used in PTZ control, serial keyboard control .

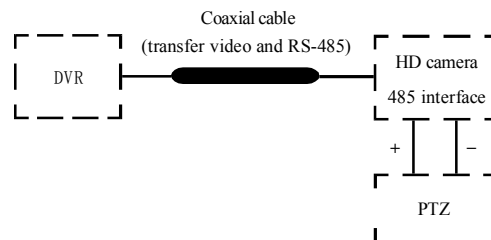

3.3.6 Keyboard Controlling

If you want to unify control more than one DVR, you have to use the series keyboard (we suggest user using one series keyboard to control more than one DVR in the same model). The function of the keyboard is the same with the front panel of DVR. (หมายเหตุ: the keyboard must be added with the protocol from our company and go through the test of our company). Take the RS485 interface series keyboard for example:

1. "Main Menu" -> "System Setup" -> "COM", to setup the COM number and COM device (series keyboard).
2. Connect between RS485+ of the keyboard and RX+ of the DVR, also RS485- of the keyboard and RX- of the DVR.
3. Connect with the power supplier.
4. Choose the "Switch" key to change mode to DVR mode, the default is "DVR-01", "01" is address code of keyboard.
5. Address code of keyboard: choose the "shift" key to enable the up key of the keyboard, then click "address/enter" to input the host address code, then you can control the DVRs.

หมายเหตุ: The detail set of keyboard can refer to the user manual of keyboard.



3.3.7 Intercommunication Port

Intercom interface multiplexes with 1st audio input interface, support active or passive microphone.

|||| User Manual

3.4 Front Panel Description





អំពីផ្ទៃមុខ: Different front panel maybe have little different buttons. Below introduction is only for reference.

S.N	Name	Mark	អំពីផ្ទៃមុខ
1 (Power)	On/Off		Turn on/off DVR.
2 (Number/Letter)	Number/Letter 0-9/A-Z		<ol style="list-style-type: none"> 1. For video channel shift, 1-8 number corresponds to CH1-CH8. 2. The number keys are used for switch channels when playback mode. 3. When setting parameters, select number and English letter input.
3 (Function keys)	* /Preset		It means preset when in the PTZ control status.
	# /Call		It means call when in the PTZ control status.
	PTZ		Press the PTZ key, when light on, it's in PTZ control, press again to cancel the PTZ control.
	Login/Lock (Auto)		<ol style="list-style-type: none"> 1. Be used to login or lock system. 2. It means auto when in the PTZ control status.
	Shift (Zoom+)		<ol style="list-style-type: none"> 1. Shift real time display. 2. It means "zoom+" when in PTZ control status.



3 (Function keys)	Format (Zoom-)	1. Shift between single and multi channel video when in real time display. 2. It means "zoom-" when in PTZ control status.
	Image (Iris)	1. Set parameters of each channel, without menu state is valid. 2. It means "iris+" when in PTZ control status.
	Clear (Iris-)	1. Edit cancel. 2. Alarm clear. 3. It means "iris -" when in PTZ control status.
	Page up (Focus+)	1. The drop-down menu option switch. 2. It means "focus+" when in PTZ control status.
	Page down (Focus-)	1. The drop-down menu option switch. 2. It means "focus -" when in PTZ control status.
	Return (Wiper)	1. Exit and return to the up menu. 2. It means wiper when in PTZ control status.
4 (Shortcut key for menu)	Rec.	Enter the manual record rapidly in without menu status.
	Playback	Enter the playback rapidly in without menu status.
	Backup	Enter the backup rapidly in without menu status.
	Information	Enter the system info. rapidly in without menu status.
	Menu	Enter the main menu rapidly in without menu status.

|||| User Manual

5 (Indication lamp area)	POWER		While supply power to DVR and the system running, this lamp will be lighted. When power supplier cut off, this lamp will be off.
	HDD		Hard disk indication: It's light when the hard disk is working or it's off.
	IR		IR remote controller indication lamp, it's light when you use the IR remote controller.
	ALARM		Alarm indication lamp: it's light when there is alarm or it's off.
	LOCK		Lock indication lamp: it's light while the remote controller is lock.
	NETWORK		Network indication lamp: it's light while the network is connected.
	PTZ		PTZ indication: It's light while entering PTZ controlling status, or it's off.
6 (Direction key)	UP/Slow play		1. Cursor move; 2. Slow play; 3. It means up while in PTZ control.
	Down/Frame on		1. Cursor move; 2. Frame on; 3. It means down while in PTZ control.
	Left/FB		1. Cursor move; 2. FB; 3. It means left while in PTZ control.
	Right/FF		1. Cursor move; 2. FF; 3. It means right while in PTZ control.
	OK/Play/Pause		1. Confirm select; 2. Play/Pause.
	Shuttle turn left and turn right		1. Cursor move; 2. Turn left means FB, turn right means FF while in playback status.



3.5 IR Remote Controller Operation

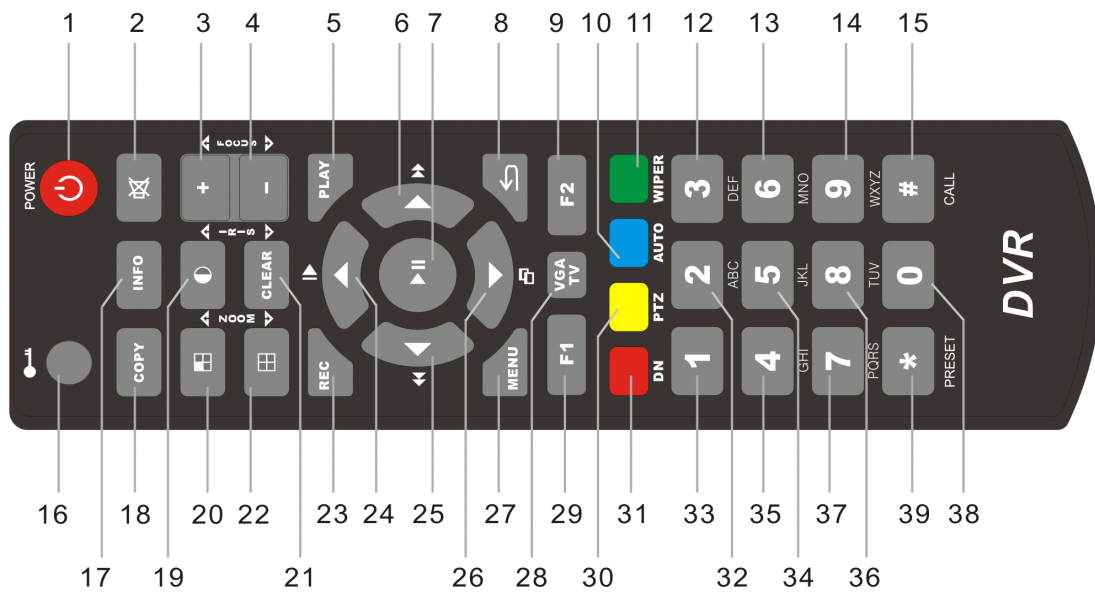

|||| User Manual ---

Keystroke instruction		
1. Power	14. 9WXYZ	27. Menu
2. Mute	15. CALL	28. VGA/TV
3. +, Focus+	16. Log in/Log off	29. F1
4. -, Focus-	17. Information	30. PTZ
5. Playback	18. Backup	31. Server Index
6. Right/Fast Forward	19. Image/Iris+	32. 2ABC
7. OK, Play/Pause	20. Shift/Zoom+	33. 1
8. Return	21. Clear/Iris-	34. 5JKL
9. F2	22. Format/Zoom-	35. 4GHI
10. Auto	23. Record	36. 8TUV
11. Wiper	24. Up, Slow Motion	37. 7PQRS
12. 3DEF	25. Left, Backward	38. 0
13. 6MNO	26. Down, Frame Forward	39. *, Preset

(หมายเหตุ: F1 and F2 are preserved functional keys.)



3.6 Mouse Operation

Besides front panel and remote controller, mouse also can be used to control the DVR'System.

Right click the mouse:

1. If the system is in login status, right click the mouse, then shortcut menu will display as right picture:
2. If DVR is locked and in real time monitor status, the login menu will pop out when right click the mouse. The system default setting user name is "admin", and password is 888888 (Left click mouse to open soft keyboard. Right click mouse in blank area to close soft keyboard after finish inputting).
3. Once entering the menu, right click the mouse, it will let you exit the current interface and back to the former menu or exit the main menu. (right click mouse has same function with close when have menu)
4. If have soft keyboard in login interface, right click mouse on soft keyboard after input, the soft keyboard will be disappeared.

Left click the mouse:

1. Left click the mouse, and you will enter the functional menu.
2. In the main menu, left click the close icon at the right up corner to close the menu and return to the up one level.
3. In the main menu, left click to access or set up the parameters.
4. When selecting the motion detection setup, left click the mouse to change the status of the motion detection square unit.
5. To set up the video images parameters, you can change the brightness, contrast, saturation, hue of the image by left click the mouse on a certain point you prefer.
6. For input box, left click to enable the soft keyboard (the default is english character soft keyboard, click the Caps to shift the case), continuous click the icon of the right of input box can switch to different soft keyboard (number, symbol, English character), mean can input number, character, symbol, clear, space, enter etc.
7. In split-screen format preview, long press the mouse left key and drag the channel to other channel position then loosen to change the channel display position.
8. In real time preview, long press the mouse left key and drag the time to the needed position then loosen to change the time display position.

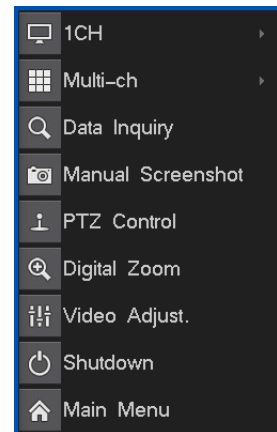

|||| User Manual

Double left click the mouse:

1. Double left click in preview can switch single channel and multi channel.
2. Double click the mouse can clear the mask area and motion area.
3. After callout the PTZ control interface, double click the mouse to move the PTZ control interface to pointing place.

Soft keyboard interface as below:

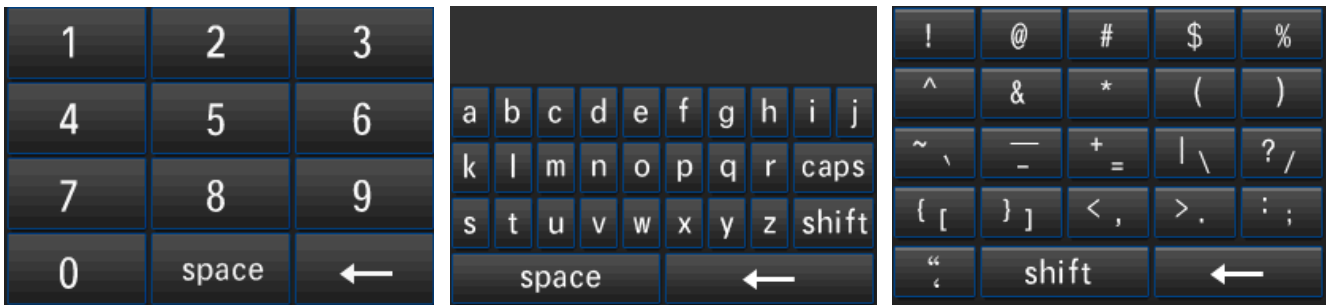



3.7 Menu Operation Description

3.7.1 Menu Structure Chart

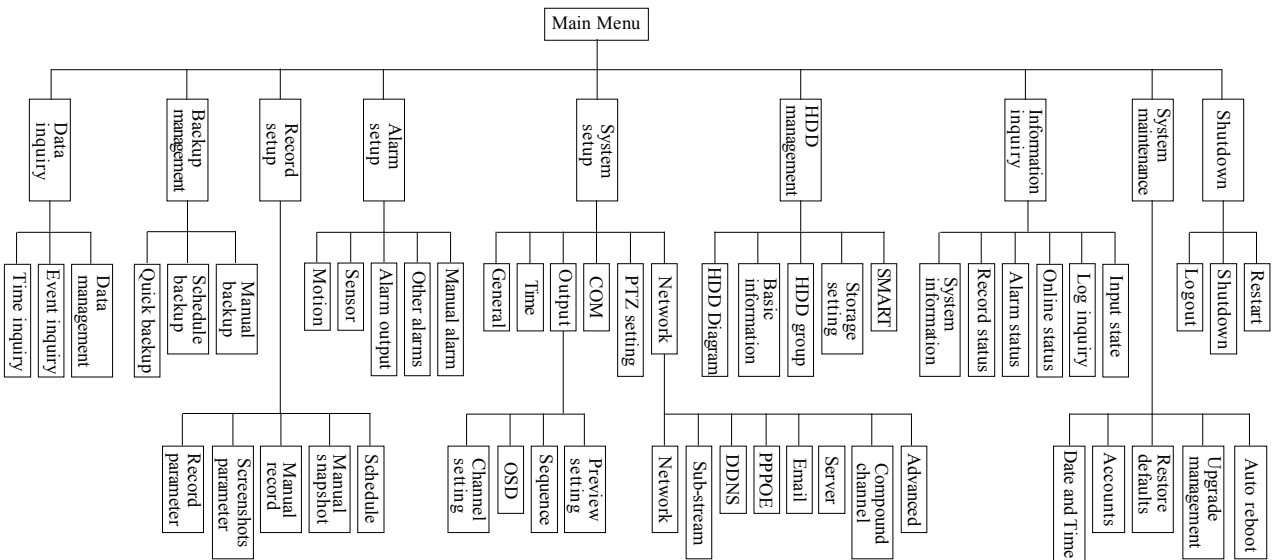

|||| User Manual

3.7.2 Menu Option Schedule

Menu	Instruction	
Data Inquiry	Time Inquiry	Query the record/pictures by time, and with video data graphical display to precise playback.
	Event Inquiry	Query and playback by event type of record/pictures.
	Data Management	Lock/unlock/delete the files.
Backup Management	Backup/inquiry/playback for record/pictures (quick, schedule, manual).	
Record Setup	Record Parameter	<ol style="list-style-type: none"> 1. Record mode: all, manual, schedule, motion detection and alarm record; 2. Bitrate type: VBR, CBR; 3. Definition: 720P, 960H, FD1 (according to the model and video source types to decide); 4. Image quality: 6 level (highest, higher, high, middle, low, lowest); 5. Frame rate: 5-25/30 fps adjustable (720P), (according to the model and video source types to decide); 6. Bitrate: 512K, 768K, 1M, 1.5M, 2M, 3M, 4M, User define (960H /FD1); 2M, 3M, 4M, 6M, User define (720P); 7. Audio: enable indicate record audio, unable indicate don't record audio, the digital audio and analog audio can be chose; 8. Pre-record time (5-30S), delay record time (1-180S).
	Screenshots Parameter	<ol style="list-style-type: none"> 1. Screenshot type: manual, schedule, motion, Alarm; 2. Definition: 720P, 960H /FD1, CIF (according to the video source types to decide);



Record Setup	Screenshots Parameter	3. Image quality: 6 level (highest, higher, high, middle, low, lowest); 4. Screenshot period: 1-5S, screenshot Number: 1 pcs (schedule, motion, alarm); 5. Enable the screenshot (schedule, motion, alarm).
	Manual Record	Enable manual record.
	Manual Screenshot	Enable manual screenshot.
	Schedule Record	Enable schedule record. set the record deployment time period, channel copy function.
Alarm Setup	Motion	1. Alarm continuous: after enable, motion alarm will be continuous if continue to have action in picture; 2. Motion detect sensitivity: 1-5 level (5 is the highest); 3. Set motion detection area, time, channel copy function; 4. Linkage setting: triggered record, screenshot linkage, alarm output, email linkage, PTZ preset point.
	Sensor	1. Sensor type: normal on/off; 2. Sensor number, deployment time, channel copy function; 3. Linkage setting: triggered record, screenshot linkage, alarm output, email linkage, PTZ preset point.
	Alarm Output	1. Alarm duration (2-300S), audio, full screen; 2. Deployment time of output alarm.
	Other Alarms	1. Alarm type: HDD error, video lost, network disconnect, over temperature, video shielding, disk full; 2. Alarm linkage: alarm output, email linkage.
	Manual Alarm	Test alarm output by manual, trigger alarm or close alarm but manual when happen urgent things.

|||| User Manual

System Setup	General Setting	<p>1. Host name, Open remote control lock, Host id;</p> <p>2. Resolution: 1024*768, 1280*1024, 1440*900, 1280*720, 1920*1080;</p> <p>3. Language: English; 4. Display device: VGA;</p> <p>5. Auto lock: 1-10 minutes can be chose or close;</p> <p>6. Audio device: microphone, sound pick-up;</p> <p>7. Choose device when booting up, display power on wizard;</p>		
	Time Setting	<p>1. Time setting: edit the time by manual, Time mode switching (12hour mode/24hour mode) and DST setting;</p> <p>2. NTP: update the time by manual/auto through network and NTP server.</p>		
	Output Setting	Channel setting	<p>1. Set the channel name;</p> <p>2. Set video mask area and special area;</p> <p>3. Video adjustment: scene setup , Brightness, Contrast, Saturation, Hue, NR;</p> <p>4. Set the channel name position of each channel;</p> <p>5. Channel copy function.</p>	
		OSD	Date format setup, time, channel name, temperature display position.	
		Sequence Setting	Sequence cruise channels, polling interval, sequence cycle.	
		Preview Setting	Set up the output preview display of VGA and HDMI.	
	COM Setting	COM number, COM device, Baudrate, Date bit, Stop bit, Parity bit, stream control, Interface type.		



System Setup	PTZ Setting	PTZ protocol, address code, communication port, channel copy function.	
	Network Setting	Network Setting	Obtaining an IP address automatically, IP address setting, reserve IP setting, port setting, multicast setting.
		Sub-Stream	1. Code stream type: VBR, CBR; 2. Definition: FD1/CIF/QCIF; 3. Image quality: 6 level (highest, higher, high, middle, low, lowest); 4. Frame rate: 5-25/30 fps adjustable; 5. Code rate: 512K, 768K, 1M, 1.5M, 2M, 3M, 4M, User define (FD1); 100K, 256K, 512K, 768K, 1M, User define (CIF); 45K, 60K, 90K, 128K, 256K, User define (QCIF);
		DDNS	Choose DDNS server, set user name and password for analysis, DDNS test.
		PPPOE	Set user name and password for PPPOE or 3G dial up.
		Email Setting	Set server, sender name, password, sender address, receiver address, port, Email test.
		Server	Connect the IP Server and configure the related parameters automatically.
		Compound Channel	Enable the compound channel and set the parameter.
		Advanced setting	1. Configure mapping port in UPNP; 2. FTP upload settings.

|||| User Manual

HDD Management	Basic Info.	Display status and information of each HDD/USB/burner, format the HDD/log, try to use HDD and set attribution.
	HDD Group	Set the HDD and record channel belong to different group, display the HDD total capacity, free capacity, record time.
	Storage Setting	Set the related parameter such as overwrite mode, trigger time, video / image and the saving days.
	SMART	Query the HDD model, serial number, firmware version, temperature, health status and SMART attribution.
Information Inquiry	System Information	Query and display the device model, software version, SCM version, hardware version, IP address, MAC address, language, resolution, active ID.
	Record Status	Display the record status of each channel.
	Alarm Status	Display the alarm status of each channel (sensor alarm, motion alarm, video loss, video shield), HDD alarm, network disconnect alarm, temperature alarm and alarm clear.
	Online Status	Display all ID in this device, including user name, IP, Login time..
	Log Inquiry	Inquiry the system log, display the log quantity and backup log.
	Input State	Display the video/audio source type.
System Maintenance	Quick Settings	Quick set time, network setting, HDD information inquiry, recording parameters, manual record.
	User Management	<ol style="list-style-type: none"> 1. Add new user, delete user/group; 2. Change password and administration authority, user group setting, IP/MAC Lock-up.



System Maintenance	Restore Defaults	Reset Default: reset various various parameters to defaults and reset factory setting.
	Upgrade Management	FTP upgrade, USB upgrade.
	Auto Reboot	Enable system schedule function to set the restart time.
Shutdown	Logout	Log off current user.
	Shutdown	Shutdown (please press the power switch on front panel when use this option to shutdown).
	Reboot	Reboot at local.
Right key menu	Single View	Quick shift to single channel.
	Multi-view	Quick shift the format of channel.
	Data Inquiry	Quick access data inquiry.
	Manual Screenshot	Screenshot instantly.
	PTZ Control	Call PTZ control interface.
	Digital Zoom	Quick access the zoom in setting interface in real time preview.
	Video Adjustment	Video parameter adjustment (scene setup, brightness, contrast, saturation, Hue, NR).
	Shutdown	Shutdown (please press the power switch on front panel when use this option to shutdown).
	Main Menu	Quick access the main menu.

Chapter 4 Device Operation

4.1 การใช้ใช้งานพื้นฐาน Basic Operation

เปิดเครื่อง: หลังต่อสายหม้อแปลงไฟฟ้า,แผงหน้าเครื่องจะเริ่มทำงานและเข้าสู่สถานะพร้อมใช้งาน. กดปุ่ม “Power” บนรีโมทค้างไว้วินาทีเพื่อเริ่มใช้งาน.

ปิดเครื่อง: เมื่อเครื่องอยู่ในสถานะทำงานอยู่, กดปุ่ม “Power” บนรีโมทจะมีหน้าต่างแสดงบนหน้าจอ.กดปุ่มยืนยัน “Confirm”, เครื่องจะปิดสู่สถานะStandby.

เข้าใช้งาน/ล็อก: เพื่อเลี่ยงปัญหาผู้อื่นใช้งานเครื่องโดยไม่ได้รับอนุญาต, เราควรตั้งฟังก์ชันถามรหัสเข้าใช้งานเครื่องทุกครั้ง.

4.1.1 ลงชื่อ ใช้งานเข้าระบบKeystroke Unlock/Lock

หากมีการติดตั้งเครื่อง DVRsโดยระวางไว้ด้วยกันหลายเครื่อง, การใช้รีโมทอาจรบกวนเครื่องอื่นๆ. ดังนั้นเราจะตั้งฟังก์ชันล็อกปุ่มจากรีโมท.เข้าเมนูระบบ-ตั้งค่าทั่วไป(รูปเฟือง-รูปเฟือง)เปลี่ยนหมายเลข ไอดีไอเอสให้ต่างกันไปในแต่ละเครื่อง และเปิดรีโมทควบคุมการล็อกและกดับันท์ก. ตอนนี้กดปุ่มDN บนรีโมท,เครื่องDVR จะล็อก, คุณจะเห็นไฟสัญญาณล็อกชื่อ “LOCK” ที่หน้าเครื่อง. หากต้องการปลดล็อกDVR, ให้กดปุ่มDN ตามด้วยหมายเลขไอดีไอเอสที่ตั้งไว้ (หมายเลขไอดีไอเอสตั้งแต่ 0-99, ค่าเริ่มต้นคือ 1).

หมายเหตุ: ถ้าเครื่องไม่ตอบสนองจากรีโมท,ตรวจสอบให้แน่ใจว่าได้เปิดฟังก์ชันนี้ไว้?

4.1.2 ลงชื่อ ใช้งานเข้าระบบ System Login

หากเครื่องอยู่ในสถานะล็อกให้มองหารูป



กดปุ่มลงทะเบียนเข้าใช้งาน “Login/Lock” บนรีโมทหรือคลิกขวา, จะมีสัญญาณล็อกชื่อเข้าใช้งานดังนี้:

ใส่หมายเลขและรหัสผ่านกดปุ่มตกลง “ENTER”,

สัญญาณล็อกชื่อ



ทางมุมขวาล่าง

จะเปลี่ยนเป็น



อัตโนมัติ,และจะแสดงชื่อผู้ใช้งานปัจจุบัน. หลังจากนั้นคุณสามารถใช้งานเครื่องได้ตามสิทธิ์ของนามใช้งานนั้น

1. นามใช้งานเดิม: admin; รหัสผ่านเดิม: 888888.
2. หากใส่รหัสผิดกัน3ครั้ง ระบบจะเตือนและเครื่องล็อกทันที ในกรณีนี้คุณจะต้องกดค้าง “clear” บนรีโมทหรือปุ่มกดหน้าเครื่อง

3. การใส่แอมป์ใช้งานและรหัสผ่าน, คลิกเมาส์ขวา จะมีหน้าต่างคีย์บอร์ด คลิกขวาอีกทีเพื่อออก
หมายเหตุ: เพื่อความปลอดภัยกรุณาเปลี่ยนรหัสผ่านทันที.

4.1.3 การล็อกเครื่อง System Lock

เมื่อเครื่องอยู่ในสถานะเข้าใช้งานแล้ว คลิกซ้ายเมนูหลัก “Main Menu” -> ระบบ “System Setup” -> ตั้งค่าทั่วไป “General” เลือกล็อกปุ่มอัตโนมัติ เลือกเวลา(ค่าเริ่มต้น 3 นาที), เครื่องจะล็อกอัตโนมัติ หลังจากเวลาที่กำหนด
คุณสามารถกดปุ่มเมนูเข้าใช้งาน “login/lock” บนรีโมทหรือหน้าเครื่องหรือคลิกไอคอนรูปคน  ได้ ณ สถานะเพื่อล็อกเครื่อง

4.1.4 เมนูหลัก Main Menu

หลังจากลงทะเบียนเข้าใช้งานสำเร็จแล้ว,คลิกปุ่ม เมนู “MENU” บนรีโมทหรือหน้าเครื่อง,หรือคลิกไอคอนรูปบ้าน  บนแถบสถานะ, หรือคลิกขวาเลือกเมนูหลัก “Main Menu” (เมนูหลักแสดงดังรูปด้านล่าง); ชื่อเมนูเรียงจากซ้ายไปขวาดังนี้ : ดูย้อนหลัง, ตัดลอกข้อมูล, ปรับการบันทึก, ตั้งค่าแจ้งเตือน, ตั้งค่าระบบ, จัดการHDD, ดูข้อมูล, บำรุงรักษา และ เลิกใช้งาน/ปิดเครื่อง/เริ่มทำงานใหม่.

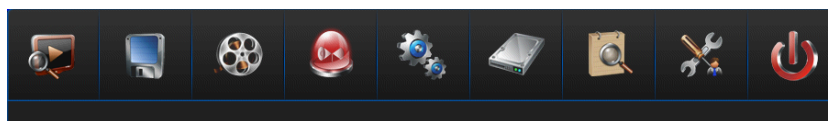











||| User Manual |||

4.1.5 แถบสถานะ Status Bar

เมื่อDVRเริ่มทำงาน,แถบสถานะที่ด้านล่างของจอตั้งรูปด้านล่าง มีการใช้งานดังนี้:



1. ไอคอนเมนู: คลิกที่รูป  ในขณะที่ได้ลงชื่อเข้าใช้งานแล้วเพื่อเข้าเมนูหลัก.
2. ไอคอนลงทะเบียนเข้าใช้งาน/ล็อกเครื่อง:คลิกปุ่ม  หลังเปิด ดเครื่องขึ้นมาใหม่เพื่อเริ่มใช้งาน, คลิกปุ่ม  เพื่อล็อกเครื่อง
3. ไอคอนสถานะแจ้งเตือน : คลิกที่รูป  เพื่อดูรายการ“สถานะแจ้งเตือน” สามารถเรียกดู / ล้างรายการ และ ปิดเสียงรื่อง
4. ไอคอนลำโพง: คลิกที่รูป  เพื่อเปิดหรือปิดเสียง
5. ไอคอนรูปแบบจัดแบ่งภาพ :คลิกที่รูป  เพื่อเปลี่ยนรูปแบบเรียงกล้อง
6. ไอคอนเลือก/ซ่อนแถบสถานะ :คลิกที่รูป  เพื่อซ่อนแถบสถานะ , เลื่อนเมาส์ไปที่รูป  คลิก หรือกดปุ่ม “Up/ Down” ที่รีโมทหรือหน้าเครื่องเพื่อแสดงหรือซ่อนแถบสถานะ
7. ไอคอนดูย้อนหลังด่วน: คลิกที่รูป  เพื่อดูภาพย้อนหลัง  เมื่อนำเมาส์มาที่ล่าสุด

4.1.6 ช่องต่อจอ Display Output

เครื่องบันทึกโทรทัศน์ X3 รองรับสัญญาณจอแสดงผลพร้อมกันสองช่อง. หมายความว่า คุณต้องเลือกช่องใดช่องหนึ่งเป็นหลักเพื่อมองเห็นเมนู GUI และสามารถใช้งานได้. อีกช่องหนึ่งจะเห็นเพียงภาพจากกล้องและตัวเลขวันเวลาเท่านั้น โดยจะไม่เห็นเมนู GUI คำแนะนำการใช้งาน:

1. HDMI,VGA และ CVBS(มีในบางรุ่น) จะมีสัญญาณออกไปพร้อมๆกัน.
2. หากคุณเลือก VGA เป็นจอหลักเมื่อเครื่อง DVRเปิดขึ้นมา, จะมองเห็นเมนู DVRการทำงานที่ VGA หรือ HDMI . คุณจะเห็นเพียงภาพจากกล้องและวันที่เวลาบนช่อง BNC CVBS หรือในทางกลับกัน
3. ถ้าคุณต้องการสลับหน้าจอแสดงผล, ทำได้โดยการเลือกเมนูสลับจอ “Display device switch” ในเมนูคลิกขวา หรือ เลือกในเมนูตั้งค่าทั่วไป หรือกดปุ่ม “TV/VGA” บนรีโมท
หมายเหตุ: X3บางรุ่นไม่มีช่องสัญญาณวีดีโอ CVBS

4.2 ตัวช่วยเมื่อเริ่มใช้งาน Power on Wizard

หลังจากเปิดเครื่องอิเล็กทรอนิกส์สาม,คุณสามารถตั้งค่าเตรียมพร้อมใช้งานตัวเครื่องได้ง่ายผ่านเมนูตัวช่วยเมื่อเริ่มใช้งาน wizard ดังนี้:
เรียกการตั้งค่า:เข้าเมนูเพื่อ(ตั้งค่าระบบ) “System Setup” -> ทำไป“General”, และเลือกเมนูช่วยเมื่อเปิดเครื่อง “Display power on wizard” กดบันทึก, ครึ่งต่อไปเมื่อเปิดเครื่องใหม่จะมีหน้าต่างถามว่า
ต้องการเข้าเมนูช่วยตั้งค่าใหม่?

หมายเหตุ: ต้องติดตั้งHDD ก่อนเริ่มใช้งานเมนูตัวช่วยเมื่อเริ่มต้นเครื่อง wizard. การตั้งค่าพื้นฐานโดยเมนูช่วยเมื่อ wizardจะสอบถามเราดังนี้:

1. หากต้องการเข้าเมนูเริ่มต้นใช้งานกดตกลง “Yes”
2. ใส่รหัสผ่านAdmin, (ค่าเดิมคือ 888888).
3. ตั้งนาฬิกา, เสร็จแล้วกดตกลงและเลือกต่อไป “Next”.
4. ตั้งค่าเครือข่าย, ตั้งเลข IP, gateway, DNS, command port, HTTP port; กดบันทึก “Save” และกดต่อไป“Next”.
5. การจัดการHDD ,เลือกหมายเลข HDD ที่ต้องการล้างฟอร์แมทก่อนใช้งานและกดปุ่ม ฟอร์แมท “Format”, มีกล่องข้อความถาม “คุณแน่ใจจะฟอร์แมท HDD?”,กดตกลง “Yes” และรอการทำงานเสร็จสิ้น
หมายเหตุ: หากคุณเลือกล้างLog “Format log” และเลือกHDDตัวแรกในรายการเมื่อฟอร์แมท HDD, จะสามารถล้างรายการlog , มีฉะนั้นรายการ log จะยังคงอยู่
6. ตั้งค่าการบีบอัดวีดีโอ,กดบันทึก “Save” จากนั้นตั้งค่าบีบอัดวีดีโอของHDD และส่งผ่าน network stream, หากต้องการตั้งค่าช่องอื่นๆเหมือนเช่นนี้,เลือกคัดลอก “Copy” และเลือกหมายเลขกล่องอื่นที่ต้องการคัดลอกไปใส่
กดปุ่มบันทึก “Save” จากนั้นกดปุ่มต่อไป “Next”.
7. ตั้งการบันทึก, เลือกหมายเลขกล่องที่ต้องการบันทึกแบบทันที กดปุ่มบันทึก “Save” และกดปุ่มเสร็จสิ้น “Finish” เพื่อออกจากเมนูช่วยเมื่อตั้งค่าเริ่มใช้งาน wizard.

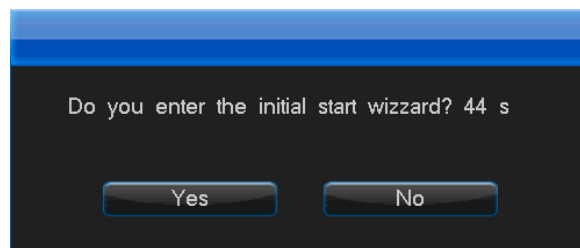

||| User Manual |||

4.3 เรียกดูวีดีโอและเล่นย้อนหลัง Data Inquiry and Playback

เข้าเมนูเล่นภาพย้อนหลังโดยการกดเล่น “Play” บนรีโมทหรือปุ่มลูกศรขวาหน้าเครื่องเลือกค้นหาข้อมูล “Data inquiry” หรือเลือกไอคอนเล่นภาพย้อนหลังจากเมนูหลักด้านล่าง “Playback” (ดังรูป), ยืนยันเข้าสู่เมนู.

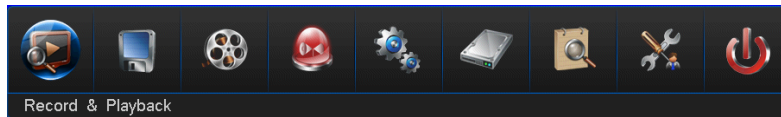

4.3.1 ค้นหาตามช่วงเวลา Time Inquiry

ในเมนูค้นหาตามช่วงเวลา “Time Inquiry”, กดวันที่ที่ต้องการบนปฏิทินและกดเรียกดูข้อมูล “Inquiry”, คุณจะเห็นสายเส้นข้อมูลเป็น แถบสีตามช่วงเวลา24ชั่วโมงดังรูปด้านล่าง:

- เลือกชนิด: วีดีโอ หรือ ภาพนิ่ง.
- เลือกกล่องที่ต้องการ.
- คลิกบนแถบสีตามช่วงเวลา (ขีดสีขาวจะบอกเวลาที่เริ่มเล่นย้อนหลัง) หรือใส่ตัวเลขเวลาที่ถูกต้อง และกดเล่น “Play” วีดีโอ
- ดับเบิลคลิกบนเส้นแถบสีเพื่อเล่นย้อนหลัง, ขีดสีขาวจะบอกเวลาที่เริ่มเล่นย้อนหลัง.
- ในปฏิทิน, วันที่มีแถบสีน้ำเงินคือมีข้อมูลบันทึกอยู่, ส่วนวันที่มีแถบสีฟ้าคือวันที่เลือกไว้, ตัวเลขวันที่สีพื้นหลังดำคือไม่มีข้อมูลบันทึกและไม่ได้เลือกวันนั้น.
- แถบเส้นข้อมูลสีเขียว “green” คือบันทึกถูกเงิน, สีน้ำเงิน “blue” คือตั้งเวลาบันทึกไว้ล่วงหน้า, สีเหลือง “yellow” คือบันทึกตามการเคลื่อนไหว, สีแดง “red” คือบันทึกจากเซ็นเซอร์กระตุ้น. (สีของภาพนิ่งก็เช่นเดียวกับวีดีโอ)
- แต่ละหน้าแสดงได้สูงสุดกล่อง, คลิกหน้าถัดไปหรือหน้าที่แล้วเพื่อแสดงแถบข้อมูลกล่องอื่นๆ.
-

4.3.2 ค้นหาเหตุการณ์ Event Inquiry

ในเมนูค้นหาเหตุการณ์ “Event Inquiry”, เลือกกล่องที่ต้องการและประเภทการบันทึกดังรูปด้านล่างขวา:

- เลือกชนิดข้อมูล:วีดีโอหรือภาพนิ่ง.
- เลือกหมายเลขกล่องที่ต้องการ.

- เลือกชนิดการบันทึกในตัวเลือกโหมด
- เลือกรายการและคลิกเล่นย้อนหลัง“Play” หรือใช้เมาส์คลิกรายการเพื่อเล่นย้อนหลัง
- สามารถเปลี่ยนไปยังหน้าถัดไปหรือก่อนหน้าโดยกดลูกศร

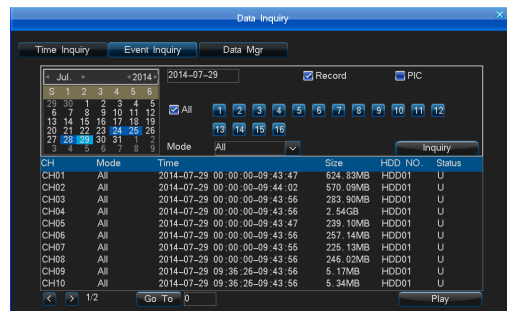
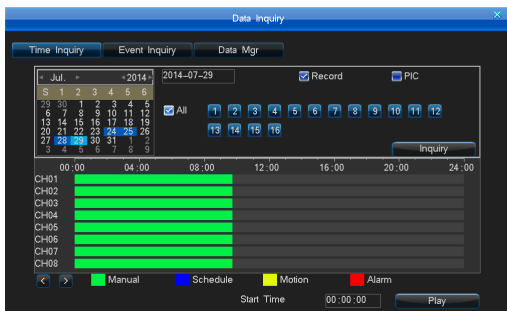

แถบเครื่องมือเล่นภาพย้อนหลัง ใช้งานดังนี้:

- เล่น: จำนวนกล้องสูงสุดที่เล่นย้อนหลังได้พร้อมกันขึ้นอยู่กับรุ่นเครื่องX3 ตรวจสอบคุณสมบัติได้ที่หน้าเว็บtomuracv.com/product.html.
- ระหว่างทำการเล่นย้อนหลัง, คลิกขวาเพื่อซ่อนหรือแสดงแถบเครื่องมือเล่นภาพย้อนหลัง.
- สามารถขยายภาพขณะเล่นภาพใด: กดไอคอนแว่นขยาย, แล้วคลิกซ้ายค้างเพื่อลากพื้นที่ปล่อยเมาส์เพื่อขยายภาพที่เลือก ; หรือคลิกขวาเพื่อยกเลิกพื้นที่ซูม,คลิกขวาอีกครั้งเพื่อออกจากการขยายภาพ.

● ในขั้นตอนเล่นย้อนหลัง, สามารถตัดวีดีโอที่ต้องการส่งออกไปเก็บที่USB-disk หรือ อุปกรณ์สำรองข้อมูล รองรับสำรองข้อมูลเป็น AVI และ DAT ,การทำงานเป็นดังนี้:

1. ขณะเล่นภาพย้อนหลัง.

2. คลิกช่วงเวลาที่ต้องการตัดเป็นวีดีโอ.

A, กดปุ่มรูปกรรไกรเพื่อเริ่มต้นตัดคลิป ดังรูปทางขวา

B, กดปุ่มรูปกรรไกรอีกครั้งเพื่อเลือกสุดท้ายของคลิปวีดีโอและตัดออกมา.

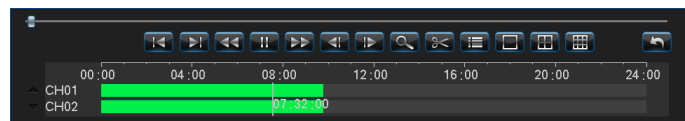

||| User Manual

3. จะมีหน้าต่างแสดงการสำรองวิดีโอขึ้นมา ดังภาพด้านล่าง

4. เลือกตัวเลือกต่าง (อุปกรณ์สำรองข้อมูล, ชนิดไฟล์, โปรแกรมเล่นวิดีโอบนคอมพิวเตอร์, จากนั้นกดปุ่มสำรองข้อมูล, รอเขียนไฟล์จนสำเร็จ.

หมายเหตุ: ไฟล์AVIไม่สามารถนำกลับมาเล่นบนDVR, ให้ใช้โปรแกรมmedia player เวิร์ดบน PC.

ไฟล์ DAT สามารถนำกลับมาเล่นได้ในเมนู จัดการไฟล์ที่ทำการสำรอง "Backup Management", แต่ไฟล์DAT จะต้องเล่นด้วยโปรแกรม nPplayer ที่มากับCD X3หรือในUSBที่สำรองข้อมูลออกมา.

- ระหว่างเล่นภาพย้อนหลัง, คลิกไอคอนรายการไฟล์ในแถบเล่นภาพเพื่อกระโดดไปยังเวลาอื่น ดังรูปทางขวา.

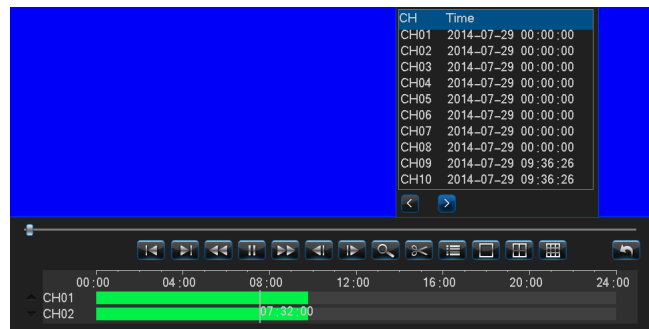
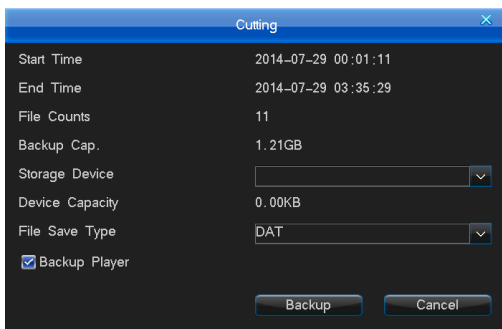

- ขณะเล่นภาพ, คลิกปุ่มตั้งค่ารูป "Image Setup" จะสามารถเลือกเล่นวิดีโอจากกล้องอื่นๆได้ ดังรูปด้านล่าง

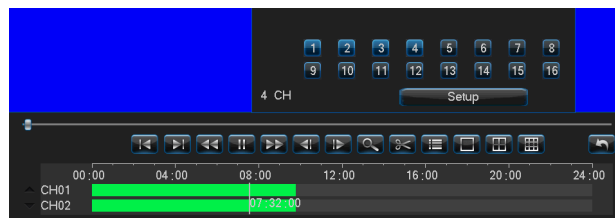

- ขณะเล่นภาพย้อนหลัง, คุณจะเห็นแถบสีว่ามีข้อมูลบันทึกอยู่ในแต่ละช่อง, คลิกสองครั้งบนเส้นเวลาเพื่อเล่นภาพย้อนหลังจากกล้องใดๆ.

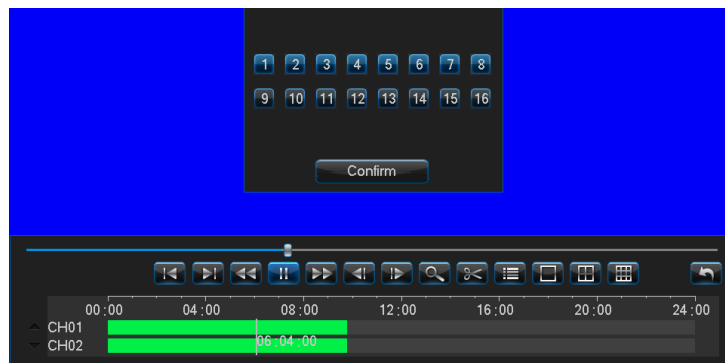

ฟังก์ชันดูภาพนิ่ง เป็นดังรูป



- รองรับเล่นย้อนหลังทีละกล้องหรือหลายกล้องพร้อมกัน.
- รองรับแบ่งหน้าจอขณะเล่นย้อนหลัง: เมื่อเล่นภาพเดี่ยวให้คลิกไอคอนแบ่งภาพ สามารถแบ่งเป็น 1/4/8ภาพและทำการเล่นหลายภาพพร้อมกัน
- เล่นต่อเนื่อง: คลิกตัวเลขเวลาในแถบเมนู จะเล่นเวลาในช่วง 43/83/163.
- เล่นทีละรูป: คลิกไอคอนลูกศรซ้าย ขวา เพื่อเล่นทีละภาพ

User Manual

4.3.3 การจัดการข้อมูล Data Management

คุณสามารถเลือก ปลอดภัย หรือลบไฟล์ภายใต้เมนู การจัดการข้อมูล“Data Management”, ตั้งเมนูรูปขวามือ:

- เลือกชนิดข้อมูล: วีดีโอ หรือ ภาพนิ่ง.
- เลือกหมายเลขกล้อง.
- เลือกโหมดการบันทึก: ทั้งหมด/ถูกเงิน/ตารางเวลา/การเคลื่อนไหว/เซ็นเซอร์.
- Use mouse to select data for lock, unlock and delete.

หมายเหตุ: Only when data in unlock status can do lock or delete operation. the recording file which is in recording process can't be deleted, when data is in lock status only can be unlocked, can't be deleted.

4.4 Backup Management

There are 2 ways for the system to backup:

1. Backup to remote PC via network (refer to client instruction).
 2. USB disk backup, supporting hot plug, the format of backup disk must be FAT32.
- “Main Menu” -> “Backup Management” to enter the interface as right bottom picture:

- Backup channel: Choose the channel for backup.
- Inquiry time: Input the time period for backup, support maximum 1 month for inquiry.
- Device type: Choose the different device type to query the local HDD saving data or backup data of every devices.
- File status: Lock or unlock.
- Data type: Record or picture.
- Mode: Choose the record type for backup.
- Backup device: Choose the backup saving device.
- File save type: Support record saved as DAT, AVI, pictures saved as DAT, JPEG.

หมายเหตุ: 1, Before backup or query the data of backup device, you must choose file saved type.

- 2, The backup data playback in DVR don't support other type of files except DAT.

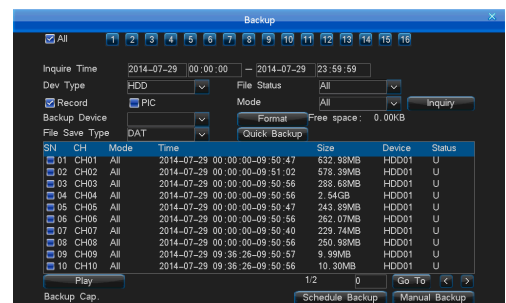
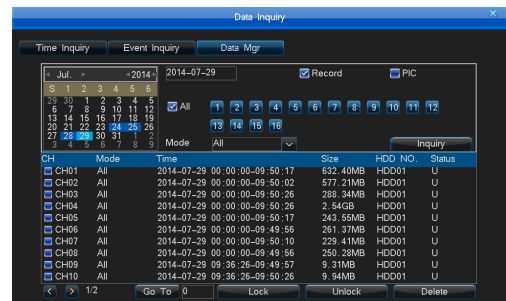



4.4.1 Quick Backup

1. In backup management interface, click “Quick backup” after choose the backup channel, file status, select record/picture and type.
2. Then a message of “Are you sure to backup?” will pop out. Select “Yes” for backup, till all of the file backup is complete.

หมายเหตุ: Quick backup is backup all data what queried.

4.4.2 Manual Backup

- Operations method as below:

1. Choose the backup channel, file status, select record/picture, type, then click “Inquiry”.
2. Select backup files, choose “Manual backup” to access backup interface.
3. Then a prompt “Are you sure to backup?” pop-up, choose “Yes” for backup, till all files backup finish.
4. If record is available then can backup, don’t need wait.
5. If you want make sure about the backup file, you can choose the file and click “Play” to play it.

หมายเหตุ: Left bottom “Backup capacity” is the total capacity of record files you chose.

- Backup file playback

1. In backup management interface, choose the backup device, then click “Inquiry”.
2. If you want make sure about the backup file, you can choose the file and click “Play” to play it.

หมายเหตุ: Backup file only support single channel playback, the progress bar can’t drag when play the backup files.

When backup DAT format record files also backup player at same time, video recorded as AVI can be played in the device.

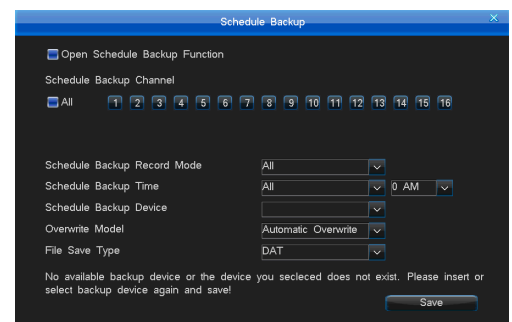

4.4.3 Schedule Backup

Click “Schedule” in Backup Management interface to enter schedule backup interface as right top picture:

Settings include: enable schedule backup function, selecting schedule backup channel, record mode, schedule backup time, backup device, overwrite model, file saved type, When the settings are save, the machine will automatically backup by the moment.

Caution: Backup time is not able to exceed 1 month. If the time of schedule backup is the same with the time of schedule restart, the latter owns higher priority.

User Manual

4.5 Record Setup

Record setting menu as right picture:

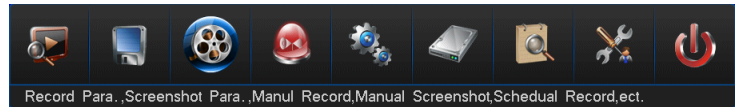

4.5.1 Record Parameter

Before using the record function, it is important to set the record parameters. It is related to video playback and hard disk capacity, etc. After login, select “Record Setup” -> “Record Parameter” to enter the interface as the right picture:

- Channel No.: Customer can select the channel by pressing “+”, “-” on remote controller or by the mouse.
- Record type: The record parameters will be active in the selected record mode.
- Encoding stream type: VBR and CBR.

VBR: It means when compress the video signal, system can adjust the compression bite rate dynamically according to the changing of the image source. Thus, when recording, system maximally saves HDD capacity, and for net transmission, the bandwidth is also maximally utilized.

CBR: The compression bit rate keeps constant even when image source changes. The characteristic for CBR is in limited bitrate to have good compression images, as well as easy to estimate the HDD occupation and network bandwidth.

- Definition: 720P,960H, FD1, according to the model and video source types to decide.
- Video quality: There are 6 levels of video quality. (highest, higher, high, middle, low, and lowest)
- Frame rate: 5-25/30 fps (720P). according to the model and video source types to decide.
- Bitrate: When compressing the intense moving image, we should make a upper limit of the compression bit rate, there are (unit:bps): under 720P is 2M, 3M, 4M, 6M, User define adjustable, under 960H/FD1 is 512K, 768K, 1M, 1.5M, 2M, 3M, 4M, User define adjustable. The “User define” can choose any value between the maximum bitrate and minimum bitrate in the corresponding definition.
- Audio: Tick off indicates open, otherwise means off, also can set digital or analog audio.
- Pre-record time: The 4 record modes support Pre-record function, default pre-record time is 10s, range is 5-30s. Due to the variable bit rate, the actual pre-record time may have some difference with what your set.
- Delay record time: The record duration time when the motion/sensor alarm appears, default duration time is 30s, range is 1-180s.
- If other channel setting are the same, click “Copy” button to enter copy interface, then select the channel which want copy. Click “Save” button.

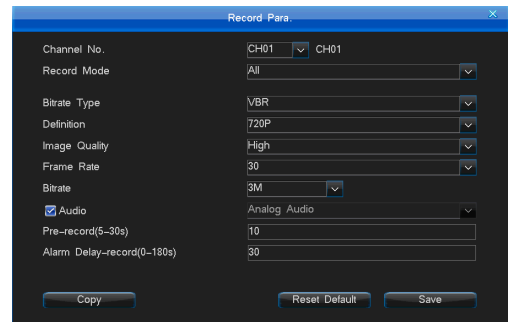



4.5.2 Screenshots Parameter

Before using DVR snapshot function, please set the snapshots parameters. It will be related to picture playback effect, snapshot interval and the picture size.

Enter “Main Menu” -> “Record Setup” -> “Screenshot Para.” interface as right picture:

- Channel No.: Select the channel which you want to set.
- Snapshot type: The snapshot parameters will be active in the selected snapshot type.
- Resolution: Support 720P, 960H, FD1, CIF, according to the video source types to decide.
- Image quality: Image quality have 6 levels: Highest, Higher, High, Middle, Low, Lowest.
- Snapshot cycle: Can set 1-5 seconds.
 - Snapshot pics: 1.

Snapshot type explaining:

- Manual screenshot in channel preview image: Right click mouse in channel preview image, select “Manual Screenshot” item, then you will snapshot a picture manually.
- Manual snapshot by system: If you open manual snapshot parameter at one certain time, the system will snapshot until you close the manual snapshot at some certain time.
- Schedule Snapshot: The system will snapshot in a regular time period. Max can set 6 time periods.
- Motion snapshot: Enable “Motion snapshot”. The system will snapshot only when it detect there have motion event.
- Alarm snapshot: Enable “Alarm snapshot”. The system will snapshot only when it detect there have alarm event.

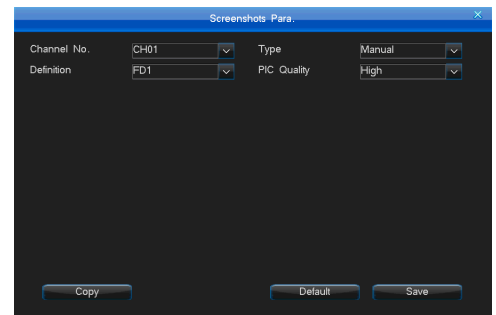

4.5.3 Manual Record

Manul Record interface as right picture:

- When enable manual record, the color of channel button is blue. Disable is gray color.
- If you open manual record, it will manual record all the time until you manual close it.

If the power supply was cut off, after it have power supply again, it will continue to manual record.

There has two way to open Manual Record.

Method 1: Press “Record” button in remote controller to enter setting interface, then choose the manual record channel.

Method 2: Enter “Main Menu” -> “Record Setup” -> “Manul Record” interface to set the setting.

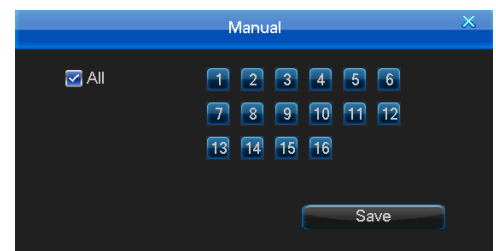

|||| User Manual

4.5.4 Manual Snapshot

Enter "Manu Menu" > "Record Setup" -> "Manul Snapshot" interface as left below picture:

- Enable manual snapshot, the channel button color is blue. Disable is gray color.
 - If you open manual snapshot, it will manual snapshot all the time until you manual close it.
- If the power supply was cut off, after it have power supply again, it will continue to manual snapshot.

หมายเหตุ: Please set the snapshot parameters before using manual record function.

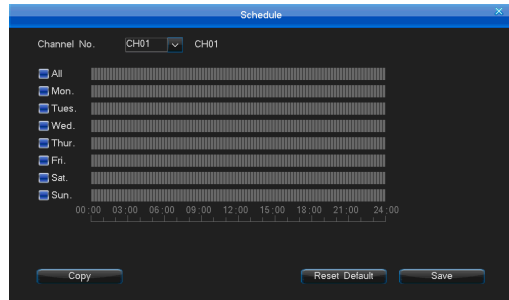
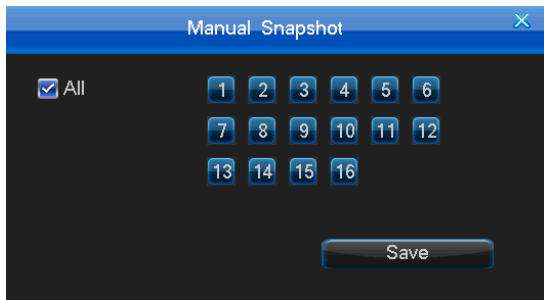

4.5.5 Schedule Record

Enter "Record Setup" -> "Schedule" interface as right top picture

1. Select the corresponding channel No..
2. Deployment time: choose the record date for setting, can be everyday or a certain day (multiple choices). Time range setting: choose the time range of record, can be set multiple range in one day, the setting of time according to the time order. Select the date through the mouse left key then set the time to take effect, drag the mouse left key to set the time range, also can be set by remote controller or double click mouse (put the poniter of remote controller at the time bar and press the enter key or double click the time bar), you can set 6 time range.(หมายเหตุ: the default time display is multiples of 15)
3. Click "Save" to activate the settings, you can also duplicate the settings to other channels.

4.6 Alarm Setup

“AlarmSetup” interface is as right:

注意: In this part, some model don't support alarm (sensor alarm, alarm output, manual alarm), please refer to actual situation.

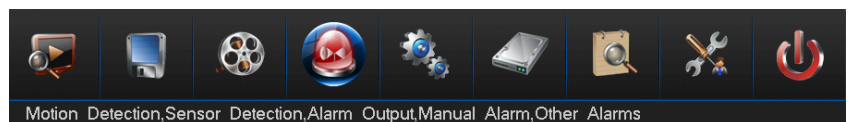

4.6.1 Motion

Enter “Motion detection” interface by “Main Menu” -> “Alarm Setup” -> “Motion” as below:

You can judge if the scene have any changes by checking the realtime record. If you want to record when there have someone or something moving in channel scene, you can set “Motion Detection” to record. User can set motion alarm record time, deploy time, sensitivity, motion detection area and alarm output channel.

Motion detection operation steps:

Step1: Enter “Main Menu” -> “Record Setup” -> “Record para.” interface to set corresponding channel pre-record time and delay-record time.

Step2: Select the channel number which you want to motion record.

Step3: Continuous alarm: after enable, motion alarm will continuous alarm when there has something moved in the video image.

Step4: Define the motion detection sensitivity level: There have 5 levels: 1(lowest level)~5(Highest level). When the system detect that have motion in the scene, it will alarm and motion record. If you choose low sensitivity, such as 1, it will alarm only when there has big change in the channel scene. If choose 5, if there have little change in the channel scene, it will motion alarm.

Step5: Detection area setting: Yellow color will detect motion. Grey color will not detect. System default the whole area will detect.

Set motion area by remote controller or by DVR front panel: Press direction key to move the cursor to make sure the start point. Press “OK” button to select, only can select a grid one by one. Press “Return” button return to motion detection interface to save the setting.

Set motion area by mouse: Left click mouse to select one start point, drag mouse to other place, then loose the mouse, it will display a area box. This area is the motion detection area. Right click mouse to return pre-interface. Double left click mouse to cancel the motion area setting.

Step6: Set the deployment time (the specific setting please refer to schedule record).

Step7: Linkage setting: Set Trigger Record, Screenshot linkage, Alarm output, Email linkage, PTZ preset point.

|||| User Manual

- Trigger Record: Select the channel number which you want to set linkage.
- Screenshot linkage: choose the channel which for screenshot linkage and set the motion screenshot at screenshot parameter menu.
- Alarm output: If alarm output setting is blue color means it will alarm when have alarm events. If is grey color mean will not alarm output.
- Email linkage: Select "Email linkage" means DVR system can send the alarm information to your email box which have set when motion alarm happens.
- PTZ preset point: System support the function of dome will turn to preset point when motion happens. (the specific setting please refer to sensor -> PTZ preset point).

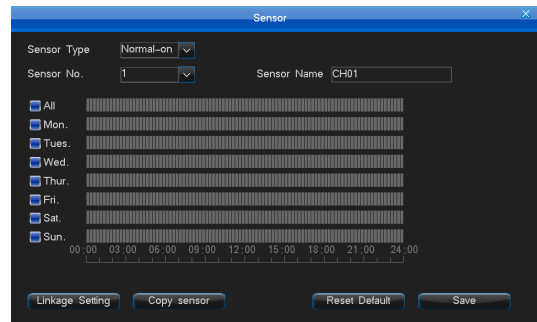
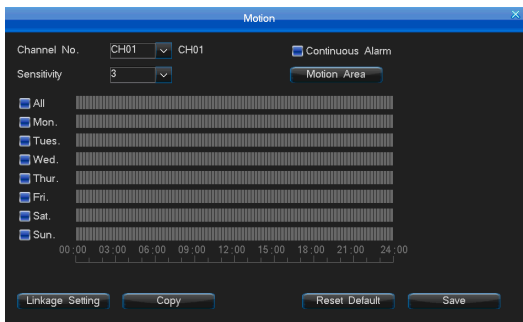

4.6.2 Sensor

Sensor alarm recording setting steps:

- Step1: Enter "Main Menu" -> "Record Setup" -> "Record Para." interface to set the channel pre-record time and delay-record time.
- Step2: Enter "Main Menu" -> "Alarm Setup" -> "Sensor", then the interface as right top picture:
- Step3: Select Sensor type: Normal on or Normal off.
- Step4: Select sensor number.
- Step5: Set sensor deploying time (the specific setting please refer to schedule record).
- Step6: Linkage setting: Set Trigger Record, Screenshot linkage, Alarm output, Email linkage, PTZ preset point.



- Trigger Record: Select the channel number which you want to set linkage.
- Screenshot linkage: Choose the channel which for screenshot linkage and set the alarm screenshot at screenshot parameter menu.
- Alarm output: If alarm output setting is blue color means it will alarm when have alarm events. If is grey color mean will not alarm output.
- Email linkage: Select “Email linkage” means DVR system can send the alarm information to your email box which have set when sensor alarm happens.
- PTZ preset point: System support the function of dome will turn to preset point when alarm happens. Setting steps as below:
 1. Select “PTZ preset point” enter setting interface. Enable “PTZ preset point available”, then set the PTZ preset point.(Note: PTZ preset point value range 1-255, 255 means close.) After finish setting, save the setting and return to sensor setting interface.
 2. Set the COM number, COM device and baud rate in COM Setting interface.
 3. Set the PTZ protocol and address code in PTZ Setting interface.
 4. Switch the image to which you want to set preset point channel, press “PTZ” button in remote controller or front panel to enter PTZ control mode. Click “Preset” button, input the preset point which you have set in step 1. Or you can right click mouse to enter PTZ control mode, then input the preset point, click “Preset” button to save the setting, at last exit the PTZ control mode.

4.6.3 Alarm Output

Enter “Main Menu” -> “Alarm Setup” -> “Alarm Output” interface as the right picture:

You can set alarm duration, audio, buzzer, full screen and alarm output deploying time.

- Alarm duration: Alarm detection time 2~300 seconds. System default as 30 seconds.
- Audio: If you select it, the alarm sound will be send out from the audio output.
- Buzzer: The buzzer in mainboard will beep after have alarm.
- Full screen: When preview image have multi-channels, if system detect alarm, the alarm channel will full screen display.
- Alarm output deployment time: System default set alarm output deployment time is everyday 00:00-23:59.

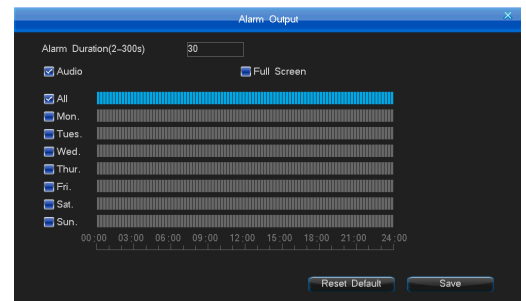

|||| User Manual

4.6.4 Other Alarms

Enter “Main Menu” -> “Alarm Setup” -> “Other Alarms” interface as left below picture:

- Alarm type: HDD error, Video lost, Network disconnection, Over temperature, Video shield, disk full. The default setting of HDD error, video lost and over temperature is enable alarm function, the default setting of network disconnection and video shield is disable, disk full. Video shield support sensitivity setting, divide into 5 level: 1(lowest sensitivity) to 5(the highest sensitivity). The default setting is the 4th level, actually according to ambient light and environmental background color to decide. If easy to trigger the alarm can reduce the sensitivity, if it is difficult to trigger the alarm must be adjust high sensitivity.
- Alarm linkage: If the “Alarm output” button is blue color, means enable alarm output when there has alarm event. If is gray color mean disable alarm output. HDD error, Video lost, High temperature, Video mask and disk fullsupport email upload function.

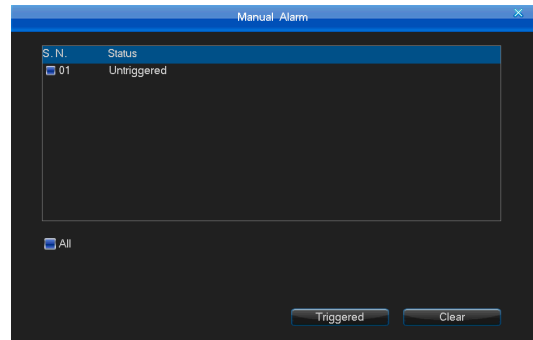
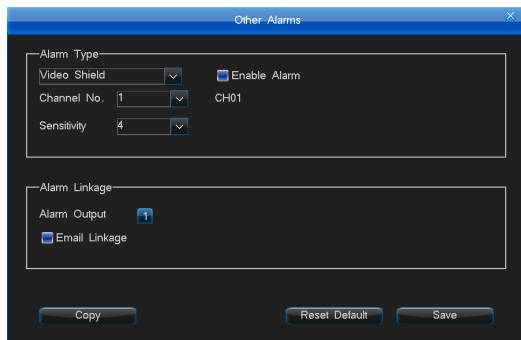

4.6.5 Manual Alarm

Enter “Main Menu” -> “Alarm Setup” -> “Manual Alarm”, the interface as right top picture:

If there has some emergency abnormal events, you can manual trigger the alarm to inform the related people.

Realization way: Left click mouse to select the alarm number which you want to alarm or you can select the “Select all” button. Then click “Triggered” button to open DVR alarm. Can click “Clear” button to close the DVR alarm sound.

4.7 System Setup

System Setup have sub-menu: General Setting, Time Setting, Output Setting, COM Setting, PTZ Setting and Network Setting, the interface is as follows:

หมายเหตุ: In this part, some model don't support COM (RS485 Full-Duplex, RS232), WLAN setting etc, please refer to actual situation.

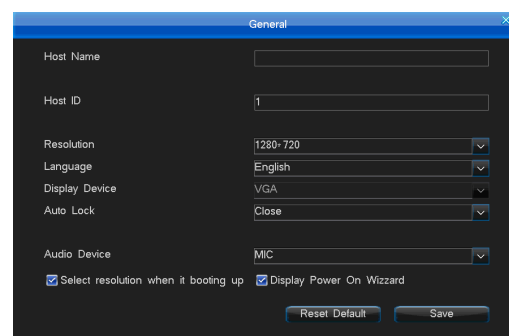

4.7.1 General Setting

Enter "Main Menu" -> "System Setup" -> "General", the interface is the right top figure above:

- Host Name: Can set your DVR host name.
- Open Remote Control Lock: Select and open the remote controller lock function, then you can lock the DVR by remote controller.
- Host id: If COM keyboard connect mult-DVRs at the same time by parallel connection, it will be as identify code to control and distinguish different hosts. And also is the host number locked and unlocked by remote controller.
- Video standard: User can choose the system video format as PAL or NTSC.
- Resolution: Support 1024*768, 1280*1024, 1440*900, 1280*720, 1920*1080.
- Language: English.
- Display device: VGA display output.
- Auto Lock: System will enter locked status when lock time (1-10 minutes) out. System default set 3 minutes. For example: Set the lock time as 3 minutes, if you do nothing operation on DVR in 3 minutes, the system will auto enter locked status.
- Power-on resolution select: you can select resolution when turn device on.
- Display power on wizard: If have selected and saved the button, the system will display "Do you enter the initial start wizard?" message after DVR restart. You can quick set "Time setting", "Network setting", "Record parameter", "Manual record" settings.

|||| User Manual

4.7.2 Time Setting

Enter “Main Menu” -> “System Setup” -> “Time” interface as left below picture :

- Time Setting:

This function is used to set or modify current system time, the system adopted the perpetual calendar. You can directly input the date number or double click to pop-out calendar table change the date, the day will change as the date’s change.

หมายเหตุ: Please check the system time when firstly use. Because system time is in close relation with video record, try not to adjust system time on general occasion.

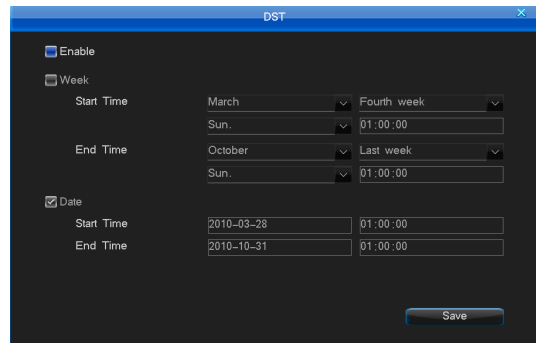
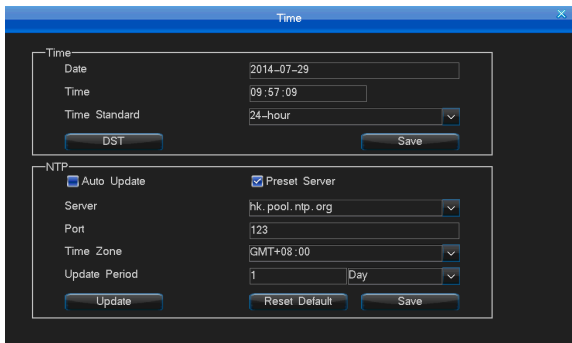

- DST Setting:

Click the “DST” button to access the setting interface (as right top picture), then set the starting time and end time through the week or date.

For example: The DST of EU countries is from the last Sunday on march to the last Sunday on October. EU countries change the time at 2:00 of the last Sunday on March in GMT. According to the time zone in different area, Western Europe time zone (UTC) countries (like: Britain, Ireland and Portugal), central Europe time zone (UTC+1) countries (like: France, Germany and Italy) and eastern Europe time zone (UTC+2) countries (like: Finland and Greece), The local time distribution form 02:00/03:00 adjust to 03:00/04:00. Inverse adjust at 03:00 of the last Sunday on October in GMT.



● NTP Setting:

NTP: NTP (Network Time Protocol) means to get current time from remote server via network to as DVR system time. Please make sure your DVR can access internet before use NTP. The default sever is hk.pool.ntp.org, port: 123, time zone is GMT+08:00.

1. Server: Normally it can timing successfully by current time server. It no need to modify the time server address. If current one cannot work, please select other time server or remove the tick “Preset server”. Then input the available time server address.

Port: Time server port. Current NTP only support TCP transmission.

Time Zone: System support 26 time zones. User can set according to current zone. Including:

London: GMT+0, Berlin: GMT+1, Cairo: GMT+2, Moscow: GMT+3, New Delhi: GMT + 5, Bangkok: GMT + 7, Hong Kong Beijing: GMT + 8, Tokyo: GMT + 9, Sydney: GMT + 10, Hawaii: GMT - 10, Alaska: GMT - 9, Pacific time: GMT - 8, American mountain time: GMT - 7, the United States central time: GMT - 6, the United States eastern standard time: GMT - 5, Atlantic time: GMT - 4, Brazil: GMT - 3, Atlantic - central: GMT - 2.

Update cycle: The unit is hour, day or week. The effective range is 1-60. Select “Auto update” button, the system will update when cycle time out. Also you can select “Manually update” button to upgrade immediately.

4.7.3 Output Setting

Enter into “Main Menu” -> “System Setup” -> “Output” interface as left below picture:

1. Channel Setting

Enter into “Output” -> “Channel Setting”, the interface as right below picture. You can set channel name, video mask area, special area, vide adjustment parameter and channel name position.

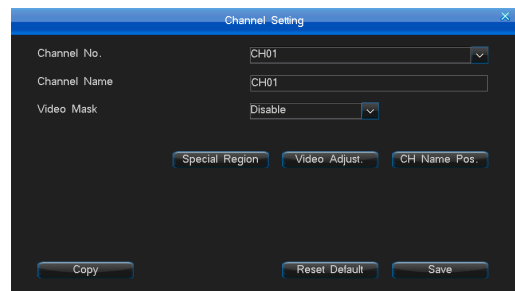
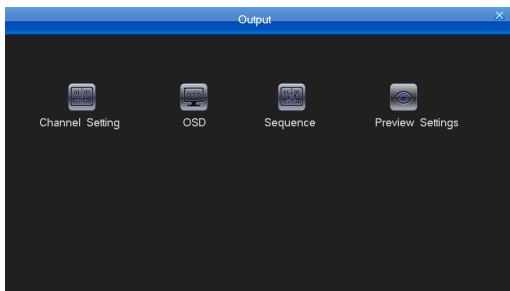

|||| User Manual

(1) Channel name

- Channel name can input max 48 characters.
- Left click mouse in the text field, then it will pop out soft-keyboard. The keyboard default as inputting english letters. Can click “Caps” button in soft-keyboard to change case. Can click the button right on the text field to switch inputting numbers, English letters, characters.
- Input by remoter controller: Continuous press numeric key to switch input ways.
- When copy channel settings, it will not copy channel name.

(2) Video mask setting

In some surveillance occasion, user need to mask the sensitivity or private area in the surveillance area of the location, such as ATM’s password area. There has 4 mask methods: Disable, Preview Mask, Record Mask, All Mask. Record Mask and All Mask max support 4 mask areas.

- Disable: Not open Video Mask function.
- Preview Mask: The channel of whole preview realtime-preview image will can not be saw. But it will be recorded.
- Record Mask: It will not show mask area in realtime-preview image, but the set area will not be saw in record image.
- All Mask: The image mask area which you have set will cannot be saw in realtime-preview, record and web access image.

Mask area setting steps:

- Select “Record Mask” or “All Mask” in Video mask drop-down list. Click “Mask Area” button in right side to enter into mask area setting interface.
- Set by mouse: Left click a pane as the start position of the mask area, then click another pane as the end position, and the area will shown.
- Set by remote controller and front panel: press direction key to move the cursor, press “OK” to confirm the start position, then move the cursor to select the area you want to mask, press “OK” again to confirm the end position. Press “Clear” to cancel the area.
- Back to the channel setting interface, click “Save” to activate the setting.

(3) Special region

The Special region which you have set will more obvious and clear. You can max set 4 special areas. The setting methos is similar to mask area setting’.

หมายเหตุ: You can only see the special area setting effect in dark case. It will have no difference under normal circumstance.

(4) Video adjustment

- Click “Video adjustment” button in channel setting interface to enter into channel parameter setting interface. Or you can press “Image” button in remote controller or front panel to enter “Video Adjustment” interface after login DVR as right figure:
- Channel No.: Used to switch channels, user can also setup all channels directly.
- Scene setup: Standard, indoor, outdoor, low light, custom (in this scene, you can set brightness, contrast, saturation, chroma)
- Enable NR: the default status is disable, Tick the “Enable NR”, to achieve image denoising, reducing image noise, the image will be a slightly blurred correspondingly.

Adjustment Method:

- Select the parameters you want to change, then press “◀”, “▶” button on the remote controller.
- Click the left mouse on the “+”, “-” to change the value, the “+”, “-” on the interface can indicate the increase or decrease of the value.

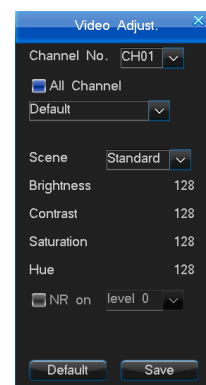

(5) Channel name position

Channel name default at top left corner. Click “CH name pos.” button to enter into channel name setting interface, drag the channel name to any position you want in the screen.

2. OSD

Enter into “Output” -> “OSD”, the interface is the right figure. You can set date format, displaying time, displaying channel name, displaying temperature.

3. Sequence

Enter into “Output” -> “Sequence”, the interface as left below picture. The function is to realize different channels switching, can set the sequence channels, sequence image format and sequence cycle.

- Sequence Cycle: Sequence interval is 3-60 seconds.
- Division Mode: Have 1 image, 4 images, 9 images, 16 images four options.
- Sequence channel no.: It will the same or bigger than the number of division mode.

หมายเหตุ: Function only available when DVR in lock status!

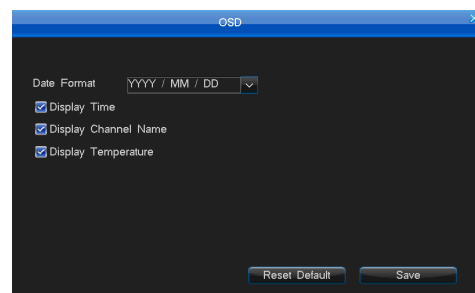

|||| User Manual

4. Preview Settings

In the “Output Settings” interface, select “Preview Setting” to enter the setting interface (as right below picture). This function is mainly to achieve real-time preview of the channel output.

In other words, the preview will in accordance with the selected channel format and sequence. Some series devices do not support CVBS output, specific please kind in prevail.

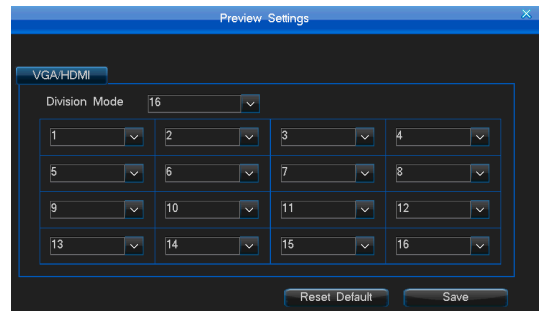
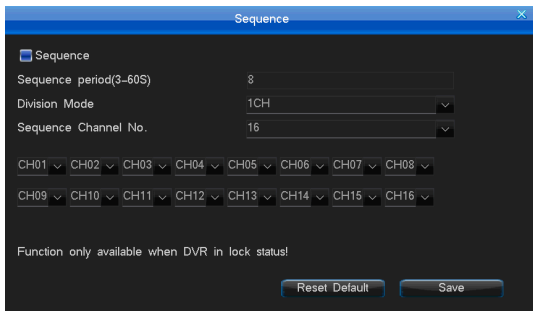

4.7.4 COM Setting

Enter into “Main Menu” -> “System Setup” -> “COM”, the interface as left below picture. You can make your DVR communicate with COM device via this setting. RS485 can control PTZ and keyboard at the same time, support half-duplex. RS485 specification: serial port type, serial port device, baud rate, data bit, stop bit, check bit. Can be used in custom set for serial port type, PTZ, keyboard, transparent interface, ATM.

- Baud rate: Set the same baud rate with the COM device, if you want to connect PTZ or control keyboard, you have to set the same baud rate with PTZ or control keyboard.
- Data bit, stop bit, check bit: Set the data bit, stop bit and check bit according to the PTZ protocol code. Commonly, the PTZ protocol’s default data bit is 8, check bit is None, stop bit is 1.
- Interface type: RS485 half-duplex; please choose suitable one according to serial port&RS484 port, for details, please take a reference at "3.3.5 RS-485 connection".
- keyboard address: set the host ID in general setting page; When one keyboard connect with several DVRs in the parallel way, the keyboard is used to control and differentiate different DVR’s identify code.

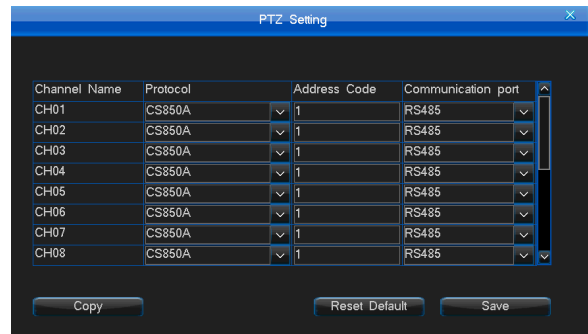
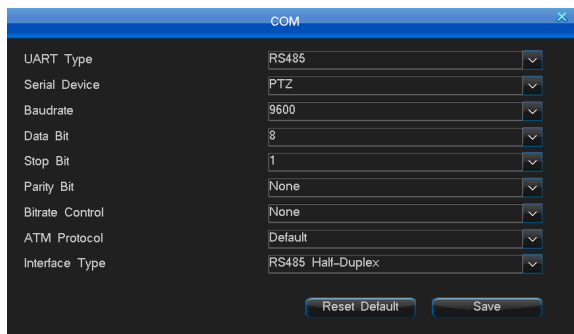

4.7.5 PTZ Setting

Enter into PTZ Setting interface by “Main Menu” -> “System Setup” -> “PTZ Setting”, the interface as right top picture:

PTZ Control Setting steps:

- Set the COM type, COM device and baud rate in COM Setting interface.
- Set the PTZ protocol ,address code and communication port. (Default PTZ address code correspond to channel number. It means the address code of first channel is 1.)
- Switch the channel which you want to control PTZ to whole screen. Press the “PTZ” key on the remote controller to get in the PTZ control mode, then you can use the remote controller to control the PTZ, press “PTZ” again you can quit the PTZ control mode; You can long press “PLAY/PTZ” button in DVR front panel (3 seconds) or right click the mouse to enter the PTZ control interface.

หมายเหตุ: Drag the interface to move it.

||| User Manual

- Setting and calling preset point by the remote controller:

Enter the PTZ status, press the direction button make the PTZ turn the direction which you want to set as preset point, press “*preset” button on remote controller and input the No. of the preset point in the text field, such as 001, then turn the PTZ to another direction, if you press the “#call” button and input the No. 001 which you preset to the text field, the PTZ will turn to the 001 preset point automatically.

หมายเหตุ: value range 1-255, 255 means close.

- Setting and calling preset point by mouse:

Enter the PTZ status, double left click mouse at the preset input text field to enable the software-keyboard and input the preset No. (such as 001). Right click mouse to quit software-keyboard, then click “Preset” to activate the setting. Then turn the PTZ to another direction, if you click the “Call” and input the No. (001) which you preset to the box, the PTZ will turn to the 001 preset point automatically. Right click mouse in blank area to exit the PTZ interface.

- Multi-preset position cruise setting: Click “Cruise setting” in PTZ control interface to enter into setting interface, set related multi-preset point cruise parameter:

(หมายเหตุ: Function only available when DVR in lock status!)

- (1) Cruise interval time: 0-99s.
- (2) Preset No.: each channel can max set 16 preset position.
- (3) Range of preset No.: 001-255, 255 means closed.

หมายเหตุ: Not all of pre-point support skip function. Some pre-point is the inner function of PTZ Camera. The calling time of some certain pre-point cannot be too short. Otherwise, PTZ camera will think that it is special operation. If PTZ camera cannot calling pre-point or calling error happens, please troubleshoot that if is the two reasons. Recommend that please read the PTZ camera user manual.

● Cruise track record: Click “Switch” button in PTZ control interface to switch to “Track record” interface (as the right picture): Cruise track is pre-record user operation of dome camera (UP, Down, Left, Right, Speed, Focus, Zoom, Iris), then repeat the same operations all the time.

Operation steps:

Open on track cruise function, first click “Track record” button, operate dome camera some time (such as up, down, speed, focus and so on), then click “End” button to finish recording track. Click “Running” button, then dome will repeat the track you have set until you operate dome manually.

หมายเหตุ: Currently only PELCOD, PELCOP, SONY, CS850B protocol support track cruise. The protocol which don't support the function will not display “Track record”, “End”, and “Running” 3 buttons.





TVI485 instruction: this function do not belong to RS485, so do not need a setup for Baud rate, Serial port device, Data bit, Stop bit, Check bit, Stream control, half/full-duplex, just need to make a PTZ setting for protocol, Address code, communication port.

TVI camera control setup:

- Enter PTZ setup interface and setup "protocol, address code, communication port"; First, select communication port as TVI485, as below left picture; Second, select Protocol as TVI-D/TVI-P, as below right picture; Then, set Address code as 1 (depends on the TVI camera that connected to DVR)

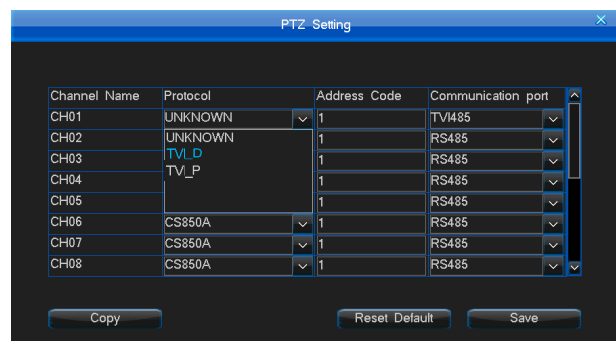
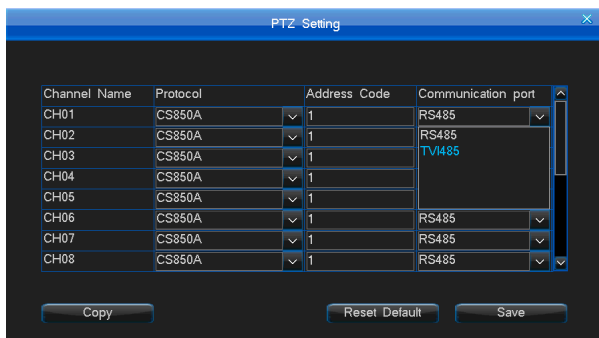

- Switch the screen that needs to control to single screen, enter cloud setup interface (press "PTZ" button on remote to entering, or press "PTZ" button on keypad, or right mouse button -> "PTZ Control" to entering), You can see "Camera setup, one-click setup" these two options.

|||| User Manual

- Camera Setup: choose "camera setup" in PTZ control interface, entering camera setup interface, as below picture. At the same time, the menu of camera parameters setting will display.

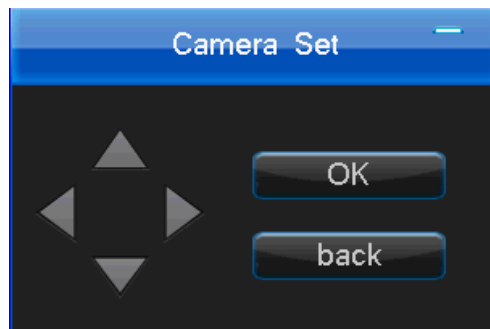

Functions of camera setting:

1. Option key: Click icon "▲", "▼" by left mouse button, select the parameters of camera;
2. Setting key: Click icon "◀", "▶" by left mouse button, modify the parameters of camera;
3. Confirm key: after selected the parameters of camera, click "confirm" by left mouse button and go to the next menu;
4. Exit key: after click "exit" by left mouse button, you will exit camera control interface, instead of camera parameters setting;
5. One-click setup key: Camera lens will auto-focus after click "one-click setup" by left mouse button.



4.7.6 Network Setting

Enter into “Main Menu” -> “System Setup” -> “Network”, the interface as below left picture:

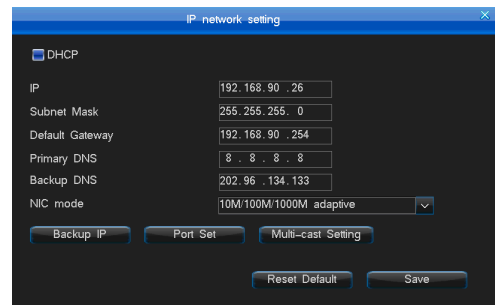
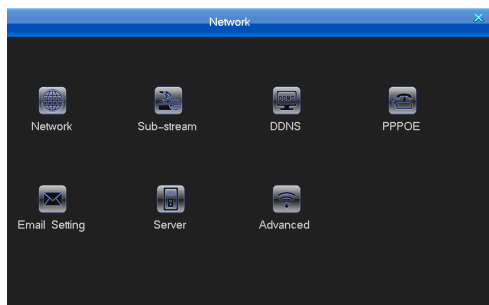

1. Network Setting

Enter into “Network” -> “Network”, the interface as top right picture:

- DHCP: If there have DHCP server, you can select the “DHCP” option, DVR will obtain a dynamic IP address from the server and displayed within the IP address column.
- IP: This IP must be unique. It can’t conflict with the IP of other servers or working stations in the same LAN. Default: 192.168.0.6.
- DNS server: Please input the DNS server address which get from local network operator.
- Backup IP: The backup IP will work when the DHCP fails.
- Port Setting: Command Port, HTTP Port, Upgrade Port.

Command Port: The communication port with client. Default is 8101, value range is 8000~9000.

HTTP Port: Web browser access port. Default is 81.The access format is: http://IP:http port.

- Multicast Setting:

Enable multicast: This function only used on UDP stream.

Multiple IP address: Multiple IP address set range is from 224.0.0.0 to 239.255.255.255; The system default is 239.0.0.1.

Multiple port: The default port is start with 8000.

注意: If there are 2 DVRs or above in one section of the net, please ensure that the multiple port is unique, or you cannot open the multiple video.

|||| User Manual

2. Sub-Stream

Enter into “Network” -> “Sub-stream” interface as below picture. Sub-stream is related to Network transmission and network record storage. When you preview DVR host playback the record by remote network, it will use the Sub-stream (Network-Stream) to transmit the data. Please refer to 4.5.1 record parameter setting.

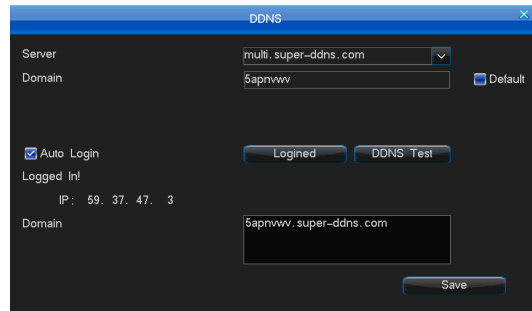
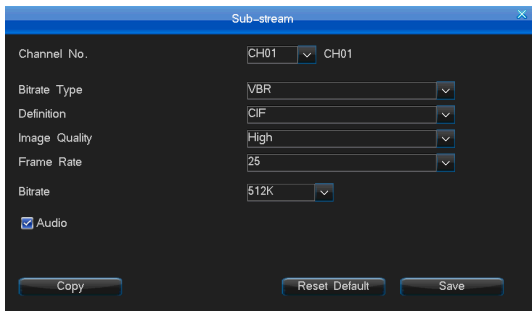

3. DDNS

When the device use PPPOE to connect WAN, access the device by DDNS can effectively solve the dynamic IP problem. It can support “multi.super-ddns.com, www.no-ip.com, http://dyn.com/dns, www.meibu.com, www.oray.com and http://freedns.afraid.org” 6 DDNS service. You can use one after have applied one account in their official website. Enter the “Network” interface, select “DDNS” to access the DDNS setting page, as right top picture:

- Neutral domain: Select multi.super-ddns.com server, check the “default” (domain name: 1 + six station after the MAC address of the DVR, for example, the MAC address in the system information is e4:7d:5a:00:29:47, then the domain name is 1002947) and then click the login, the machine will automatically register neutral domain and log in successfully. You can also manually enter any not used domain name, click login then machine will be automatically registered with the neutral name and login successfully.
- Login www.oray.cn (www.no-ip.com, www.meibu.com, www.freedns.afraid.org) to apply the oray (no-ip, meibu, freedns) DDNS service, please write down the username and the password. Choose the oray server on the DVR, input the username, password you have applied, save it, then you can see the DDNS information after a few minutes.
- Login www.dyndns.com to apply the dyndns DDNS service, please write down the username and the password. Choose the dyndns server on the DVR, input the username, password you have applied, save it, then you can see the DDNS information after a few minutes.
- DDNS test: test the account whether is available .



4. PPPOE

Select "Network" -> "PPPOE", and the interface as below left picture:

PPPOE is one of the mode to connect to the WAN: Connect to the WAN by system via dialing the ADSL directly. Please get the PPPOE account from network operator.

- Username/Password: ADSL account user name/Password.
- Auto Connect: If you select this option, system will automatically connect the WAN after disconnection.
- Connect: After you input the correct ADSL account and password, focus the cursor on the icon and press "Connecting" to connect the WAN.
- Save: If you select this option, system will automatically save the ADSL password, so you don't need to input them again when reconnect to the WAN.
- 3G dial: Insert the 3G network card into USB interface. Select "3G dial-up" button, then input the 3G user name, password, and select the correct 3G network formats. Click "Connecting" button to begin 3G connection. Please check below reason if you dial 3G failed:
 - A. Currently we only support Huawei EC1260/EC1261/EC122/E261/E353/E153 3G network card. Please check if your 3G card is anyone of them.
 - B. Please check if your 3G wireless card is matching with your telephone card network.
 - C. Please confirm you have selected "3G Dial up" button. You can input "card" in username and password input text box or input nothing.
 - D. Please confirm if you have select correct network standard (CDMA/WCDMA/TD-SCDMA).
 - E. As to the details of "APN" and "Dial-up numbers" option, please contact your Internet service provider.

หมายเหตุ: You must connect the net manually after first set the "Auto-redial".

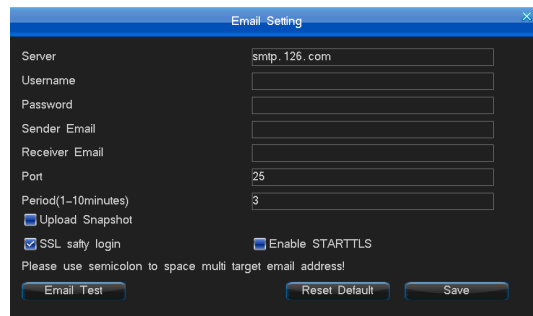
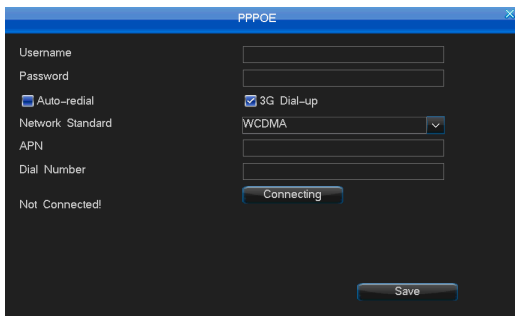

|||| User Manual

5. Email Setting

After login, enter into email setting interface follow "Network" -> "Email setting", the functions support email upload are "motion detection", "sensor detection", "HDD error", "video lost", "over temperature", "video shield", the interface as top right picture:

Email linkage setting steps:

- (1) First enable the "Email Linkage" setting in Motion or Sensor or Video lost interface.
- (2) Set the email server address. Default is smtp.126.com.
- (3) Input the email username and password which account you applied in email service provider.
- (4) Input the mail address which applied from SMTP server in the "Sender email".
- (5) Input the receiver mail box which can be multiple and separated by "," The maximum length of the letter you input is 256 bit.
- (6) Default port is 25, normally do not need to change.
- (7) Set the e-mail upload interval time, that is the time interval for upload alarm information to the target email, no matter how many times alarm triggered, it just upload once during every interval time.
- (8) Select "Upload snapshot", it will send the picture which snapshotted by the DVR system when alarm happens to the email address you have set (Video lost will not upload snapshot picture, it will only send text message).
- (9) After saved the setting, the receiver mailbox will get the alarm information mail when alarm is triggered.
- (10) Enable "SSL Secure Logon": This is option function, some email service need safe connection. Please according to actual email setting to select SSL.
For example: gmail, 163, yahoo email (port is 465) and Hotmail email (port is 25) should enable "SSL Secure Logon".
- (11) If mail unable to send, please check whether DVR can access internet, or the mail server can work well.

6. Server

After entering the "Network" interface, select the "Server" to enter setup interface (as below left picture). This interface enables to set IP Server and Active Connection Platform.

(1) IP Server

Through "Server" to "IP Server", click "Load" to enter IP Server configuration interface (as below right picture). Configuring IP Server related parameters, and can view the added device is active or not, and inactive devices last activity time on the PC side via IP Server Manage and IP Client Tools; Also can query the added active device's IP address and the IP address digits (including the decimal point) etc. IP Server using steps as below:

> Install IP Server Manage on PC side and open; Select a device group and add the device, after adding successfully there will be displayed a registration code (unnecessarily remember, it will be displayed in the IP Server Manage interface when click OK), and then click on the "Start Service" to start IP Server service.



➤ Enter IPServer interface in the DVR side to configure the following parameters:

- IP: IP address of PC where IPServer Manage located.
- Port: The “UDP Port” is 8888 in “service port configuration” of the IPServer Manage interface.
- “Register ID” means “Device Registration code” of the added device in IPServer interface.
- Check “open”, click Save and settings success.

➤ Query the IP add via IPClient tool, there are 2 ways as below:

A. Type into “device name” box with correct format, thereinto, the Server IP is equal to the IP add of the PC where this IP Server Manage located; Port is equal to “TCP Port” that is 8880; DVR_NAME means “device name”, click “Query”, then you could query the IP add of DVR.

B. Using the “Preset IP and Port” function, you can query by just typing “# + device name” in the “Device Name” input box. The method is: type the IP add of the PC where the IP Server Manage located. (Just using the default 127.0.0.1 if this is the default device), type “TCP Port” into “device port” input box, then you could query via click “Preset IP and Port”.

Notice: 1. Please check whether the “IP Server Manage” service has been started or not, if you could not query IP add.

2. There are 2 conditions, if you using under the WAN:

A. If Both DVR and PC connect to WAN directly, not via the Router, then do as per the steps above will be ok;

B. If either DVR or PC connect to the WAN via the Router, then you could set the Mapping Port in the Router, specific setting as follow: The “Mapping Port” of the Router where DVR located set as “TCP Port”, “Mapping Port” of the Router where PC located set as “UDP Port”, just need to set the only Router which has connected with DVR or PC.

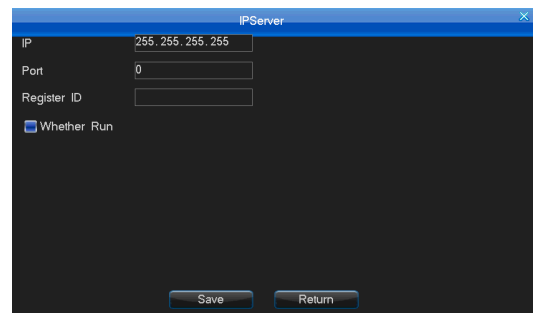
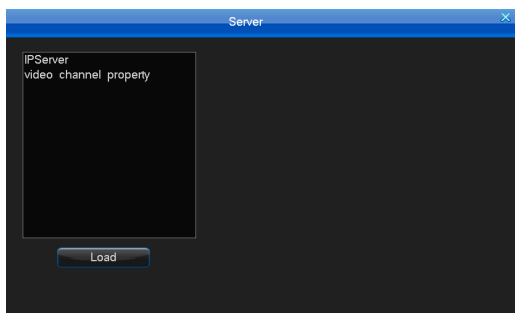

||| User Manual

(2) Video channel property

Description: Through the Video Surveillance to achieve the DVR active connection platform client (when system abnormal restart or power-off restart). The associated configuration steps are as follows:

➤ Installed the “Video Surveillance System” in the PC terminal, and then log on platform client, click on the “Configuration” -> “Device Management” -> “Add Device”, put the device name in this page; Device type selection “Initiative”, video channel number, the number of alarm input, alarm output etc., click “OK” to finish device added. After that, click “Modify” the icon, obtain device registration code (license), like the picture as below.

➤ Through the “Server” from DVR -> “Video channel property”, and then click “Load” into the configuration interface, as shown on the bottom right. Fill out the IP In this page (IP address is the same as the PC platform server address). Port (Default: 8000, the streaming media forwarding ports, platform client login page “port” or “Configuration” from Client -> “System management” page view), Register ID (device registration code), Click “Open” and save.

➤ Exit “Video channel property” interface, can see the status display “connected” when enter again and can operate to the device, as well as ordinary passive connection mode of operation.

If the connection fails, it will display the “Network Disconnected”. Device connection platform client successfully, can operate and configure the device as normal connection way by Client software.

Device Name	Device T...	Device Address	Port	Chan...	Permiss...	Modify
DVR01	Initiative		8101	16		

Change Device

Device Name: DVR01 [OK]

Device Description: [Cancel]

Device Type: Initiative [Other]

Device Address: []

Device Port: 8101

Login User: admin

Login Password: *****

Channel: 16

Alarm Input: 4

Alarm Output: 1

License: 8301340638441382

Serial: []

Video Channel Property

IP: 255.255.255.255

Port: 0

Register ID: []

Open Close

Status: Close

[Save] [Return]



7. Compound Channel

After entered into “Compound Channel” interface, you will have below interface:

Compound channel function is that it can display multiple any channels in the Compound channel in web browser netview interface.

a. Set compound channel, select “Enable” button, click “Parameter Setting” button to enter into the interface as below right picture:

b. Compound channel parameter setting please refer to “4.5.1 Record Parameter Setting”.

Operation method as follows:

- Except above setting method in DVR host, you can also set in web side. After login DVR by network access in browser, you can set the compound in “Config” -> “Channel Parameter” -> “Compound Channel”. Please refer above host side setting.
- Right click mouse to select Network Stream as TCP Main stream. double click “Compound channel” in channel list in web interface, then you will see the multiple images. You can set max 16 images. Compound channel image has not channel number display.

หมายเหตุ: Compound channel record parameters and 4.5.1 record parameters will not influence each other; Compound channel will only work as main stream, will be invalid as sub stream.

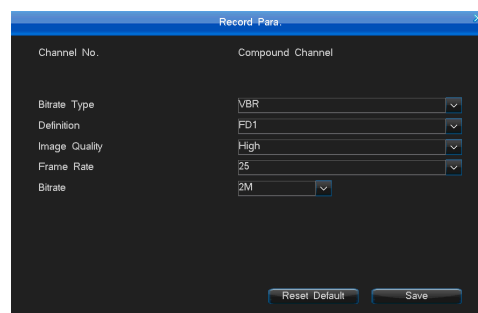
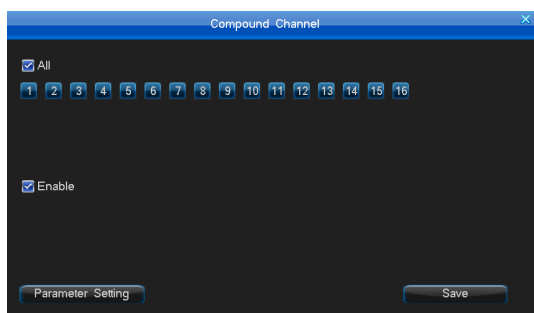

|||| User Manual

8. Advanced Setting

Enter "Network" and select "Advanced" to enter the interface (as below left picture). UPNP function and FTP record upload.

(1) UPNP settings

After entered "Advanced" interface, then select "UPNP" and click "Setup" button to go to "UPNP" setting interface as below right picture above. UPNP is Universal Plug and Play. With UPNP function, it will no need to set port mapping in router. All port mapping has been done by DVR firmware. UPNP setting steps as below:

- Set your network segment of DVR with the same with router's. (The host IP address must be the within the scope of router IP address filtering. Sub-net mask, default gateway and DNS settings should be consistent with the router). Recommend you use the DHCP function. Then manually enable UPNP in your router.

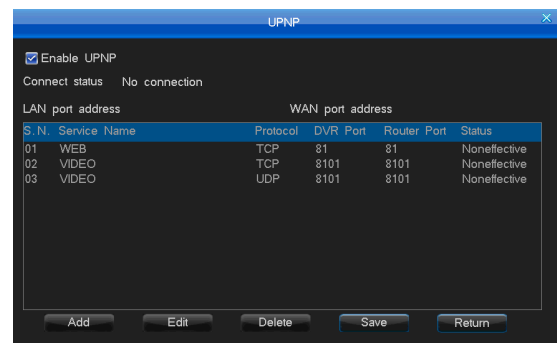
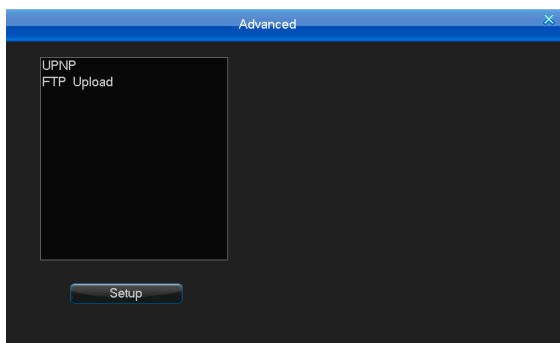

- Select "Enable UPNP" in the "UPNP" interface to enable the function. After enabling UPNP, there'll be 3 default port mappings. These mappings can't be edited or deleted. When the connect status is "Connected", these 3 mappings are available to use. If you need to add other router mapping, please use "Add" to operate.
- Click "Add" to enter the interface of "Add UPNP PAT" (as below left picture), set service name, select corresponding protocol of the router (TCP/UDP), DVR port number and router port number (could be the same for convenience). You could see the added mapping after setting and saving, meanwhile, the adding results could be seen in the UPNP setting items of the router. (หมายเหตุ: Some routers maybe don't have the UPNP setting list). The corresponding relation of DVR setting and router information display as below:
Service Name--Application Description; Protocol--Protocol Type; DVR Port--Internet Port; Router Port--External Port.



- You can check if the UPNP setting is correct by accessing DVR from web. Input “http://IP:Port” in web browser address. “IP” is DVR WAN IP. “Port” is DVR http port.
- หมายเหตุ: 1. DVR UPNP function need router support UPNP. Some router don't support UPNP. If it so, please manually set port mapping or set DMZ host address to DVR IP address in your router.
2. The network layer protocol of DVR web view and CMS is TCP protocol. If you want to preview by remote network, please set the HTTP port and command port mapping with TCP/UDP protocol in your router.

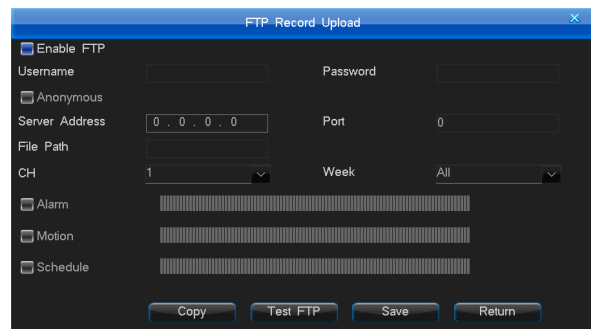
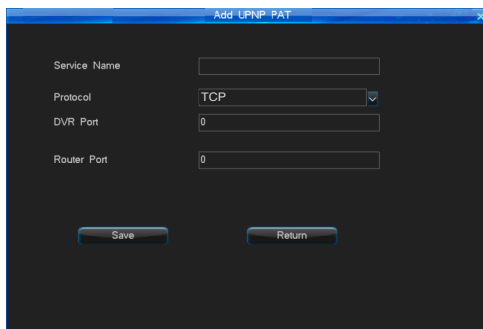

(2) FTP upload

Description: the FTP upload is via FTP server upload DVR equipment local video data initiative to PC. The specific steps are as follows:

- Double-click on the FTP server software, Configured according to guide. On the server to create a user name, the user password, specify the root directory (data upload video put drive), permissions Settings (“download”, “upload” and “allows you to create the directory” Permissions must be set).
- After the configuration is automatically entered into the server. Set the server IP (i.e., the IP address of the PC), port.
- Start the FTP service.
- In the “Advanced” interface to select the “FTP”, then click “Setup” to enter “FTP upload” screen (as top right picture), configure the following parameters:

|||| User Manual

- Username = step 1 to create a user name.
 - Password = step 1 create user name corresponding password. (หมายเหตุ: if you create user for anonymous account, do not need to fill in these two, direct check "Anonymous")
 - The address of the server = step 2 set server IP.
 - Port = step 2 set of server port.
 - The location of the file path = upload video placed. If files are stored in E: \123, then the first step is to specify the root directory of the E drive, that file path = /123.
 - Set the channel, day, video type (alarm, motion, schedule) and the time period under record type selection, click "Save". At this point, as long as the set time with the corresponding video data is uploaded to under PC the path of the corresponding FTP server.
 - Through the "FTP test" to confirm whether to connect to the FTP server is normal, after the success of the test, the PC under the corresponding file path will produce "test. txt" file.
- หมายเหตุ: 1. The timing of the FTP upload video to multiples of 15 minutes (e.g., 10:15), upload files to the point in time before 15 minutes of video data (e.g., at 10:00-10:15).
2. Week set is confirmed on video upload valid time of the operation.
 3. The period of video type choice, only when the selected time period were included in the various video set effective period to take effect, can upload video data within a set period of time.

4.8 HDD Management

After login, you can check basic information, HDD Group, Storage setting and SMART information by "Main Menu" -> "HDD Management" menu.

4.8.1 Basic Information

You can check the general information of HDD in HDD management, the interface as below picture:

1) Check the HDD general information: The first row display the disk number corresponding to disk interface; The second row display the HDD device; The 3, 4, 5, 6 rows display the partition type, status, total capacity, and surplus capacity. The system only support FAT32 format, please use the HDD which above 32G; If there have multi-partition in one HDD, the system only read the first partition.

2) Try to use: when disk is abnormal, choose the corresponding disk and click "Try to use", then the host will forced to use the disk and the host will use the normal partition in it after rebooting.

3) HDD property: There are Read-Write and Read-only two kinds of attribute, default as Read-Write. If you want to prevent that the important record to be deleted or overwrite and protect the record, you can set the HDD as Read-Only. Setting steps: Click the "Attribution" button in "Basic information" interface, then open "Disk property setting" interface, set the "Attribute" value as "Read-Only", then click "Save" button.

Enable Set: The function only work for eSATA eSATAis default as backup disk. If you want it as storage recording data disk, please set the type as "Data Area". If so, the eSATA will not supportot-plug. If you changed the settings on eSATA, please click "Save" button to take the setting effect.

หมายเหตุ: If the eSATA partition type changed, you should first format HDD.

4) HDD Format: Select the right disk number which you want to format, then click the "Format" button. Notes: When you formatting log file, you need select the right HDD which stored the log before click "Format log" button.

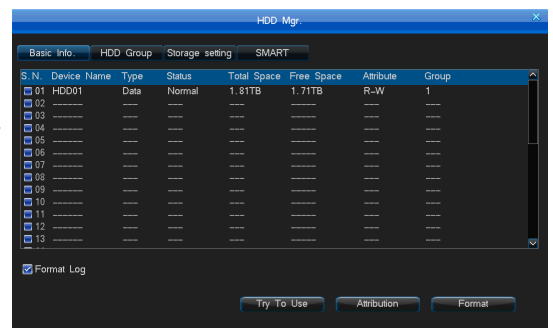

4.8.2 HDD Group

หมายเหตุ: You can choose the right channel record to specified HDD group. It can take you follow convenience:

- 1) Can make sure specified channel record to specified HDD.
- 2) According to channel data quantity size specifi the right HDD. Reasonably set each channel storage space.

In the HDD Management interface, select "HDD Group" sub-menu (as the left picture below); in this interface you can see the corresponding configuration directly (HDD number, record channels, available record time), the system supports up to four disk groups, click on "Edit" in HDD group configuration, such as the right picture below.

- HDD Number: Set the right HDD belong to the right group;
- Record Channel: Set the right channel belong to the right group;
- Total space: Display the total capacity of all HDD in the HDD group;
- Free space: Display free capacity of all HDD in the HDD group;
- Available Record Time: Display the max time of record which current HDD group can storage.

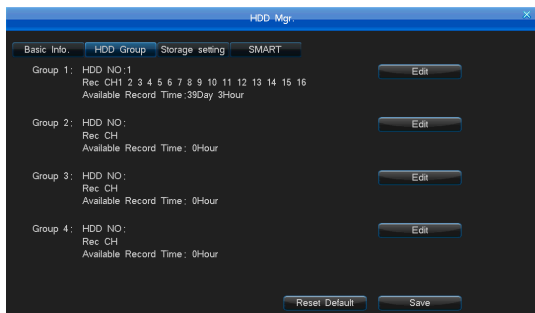

4.8.3 Storage setting

In the HDD Management interface, select “Storage Setting” sub-menu (as the left picture below).

- Record overwrite: Suggest that you can select “Auto”. When HDD is full, it will auto overwrite the oldest record file. When record overwrite happens, the HDD free capacity is 0%. “Manual” type is when the HDD is full, the system will show message that if you want to overwrite the oldest record and the same time the system will stop recording until you agree with the message.
- Trigger Time: Set the trigger point so that it will detect whether it exceeds the maximum time when the DVR reboot and enter to a new day. And it will delete the outdated data automatically.
- Channel Number: Select the channels that the video data is automatically deleted .
- Tick the “Enable” and then the video data is automatically deleted.
- Record (Picture) saved days: The previous data will be automatically deleted if it exceeds the saved days you set. (eg: set the maximum saving days to 7 days, and then the data of 1st will be automatically deleted when it comes to 8th).

หมายเหตุ: The record file which was set as “Locked” or “Read-Only” cannot be deleted or overwrote.

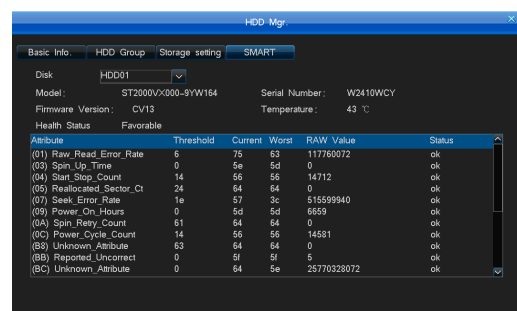
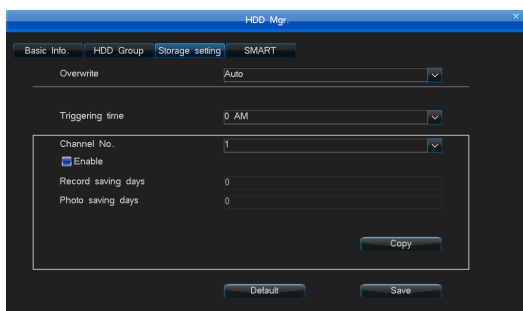

4.8.4 SMART

Choose “SMART” option interface as the right picture top. You can check the HDD SN, firmware version, temperature, state of health and other SMART values.

4.9 Information Inquiry

Check the DVR firmware version and log information by the menu “Main Menu” -> “Info. Inquiry”. The sub-menu have Sys Info. , Record State, Alarm State, Online State, Log Inquiry and Input State as below picture:

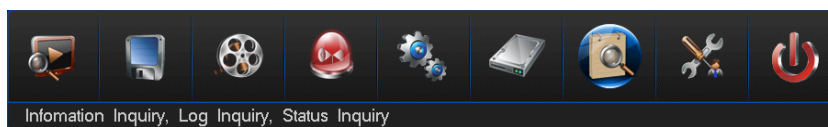

|||| User Manual

4.9.1 System Information

System information will display the interface as follows:

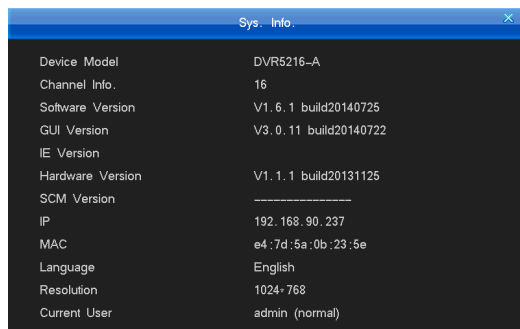

The screenshot shows a window titled "Sys. Info." with a close button in the top right corner. The window displays the following system information:

Device Model	DVR5216-A
Channel Info.	16
Software Version	V1.6.1 build20140725
GUI Version	V3.0.11 build20140722
IE Version	
Hardware Version	V1.1.1 build20131125
SCM Version	
IP	192.168.90.237
MAC	e4:7d:5a:0b:23:5e
Language	English
Resolution	1024*768
Current User	admin (normal)

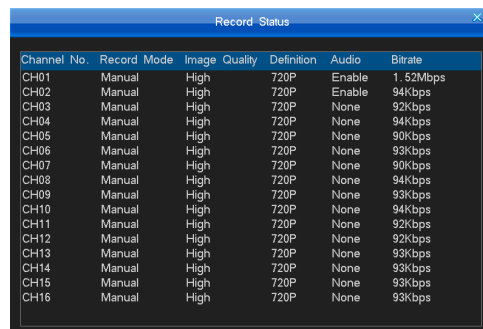

The screenshot shows a window titled "Record Status" with a close button in the top right corner. The window displays a table with the following columns: Channel No., Record Mode, Image Quality, Definition, Audio, and Bitrate. The data is as follows:

Channel No.	Record Mode	Image Quality	Definition	Audio	Bitrate
CH01	Manual	High	720P	Enable	1.52Mbps
CH02	Manual	High	720P	Enable	94Kbps
CH03	Manual	High	720P	None	92Kbps
CH04	Manual	High	720P	None	94Kbps
CH05	Manual	High	720P	None	90Kbps
CH06	Manual	High	720P	None	93Kbps
CH07	Manual	High	720P	None	90Kbps
CH08	Manual	High	720P	None	94Kbps
CH09	Manual	High	720P	None	93Kbps
CH10	Manual	High	720P	None	94Kbps
CH11	Manual	High	720P	None	92Kbps
CH12	Manual	High	720P	None	92Kbps
CH13	Manual	High	720P	None	93Kbps
CH14	Manual	High	720P	None	93Kbps
CH15	Manual	High	720P	None	93Kbps
CH16	Manual	High	720P	None	93Kbps

4.9.2 Record Status

Can quickly query system current record state. The system can display the "Record mode", "Image quality", "Definition", "Audio(Enable/None)", "Bitrate" of each channel in the state list. If the system is recording, it will display one record mode of Manual/Schedule/Motion/Alarm. It will display current definition and bitrate of current video input. And also display current audio input state. The interface as the right picture top:

4.9.3 Alarm Status

Alarm status interface as the left picture below:

Display 4 kinds of alarm information of each channel: Sensor Alarm (Red mark), Motion Alarm (Yellow mark), Video lost (blue mark), Video Shield (Green mark). You can click the "Clear" button to close alarm sound in DVR front panel or in IR remote controller. Also you can click the "Alarm Clear" icon in DVR interface status bar to close alarm sound.

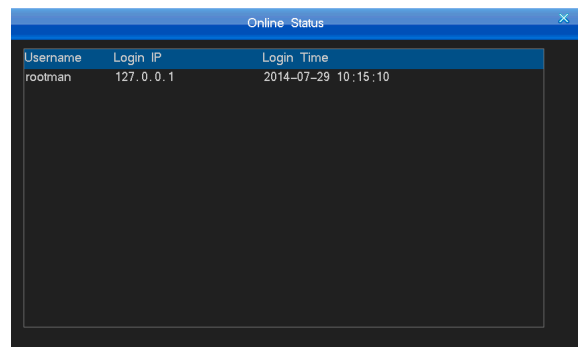
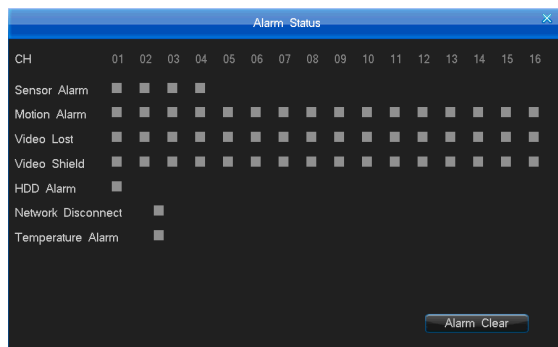

4.9.4 Online status

Display the information which PC has login the DVR. It will display the username, IP of PC and login time, the interface as the right picture top:

หมายเหตุ: Our CMS software may affect the online information displaying. If CMS has add one DVR with the IP, even if you don't open the PC Terminal, the PS Service server will connect DVR. Then it will shows the PS Service server IP address in the online state interface.

|||| User Manual

4.9.5 Log Inquiry

Log inquiry interface as the left picture below:

- หมายเหตุ: The log total number of the day which you inquired (Log information max support 1023 days, 524032 item logs); You can check the DVR host log information by web.
- System log include: System boot up/Shut down log, firmware upgrade log, alarm log, PTZ control log, System user login log, System parameter change log, Record playback log, backup log, Formating HDD log, client login log.
- System support backup log. (Backup device: USB disk, mobile HDD), you need inquiry log first before backup log.

หมายเหตุ: Log file which saved in DVR HDD cannot read directly by PC when you insert the HDD in your PC mainboard interface, you need check the log file by special DVR HDD analysis tool to inquiry.

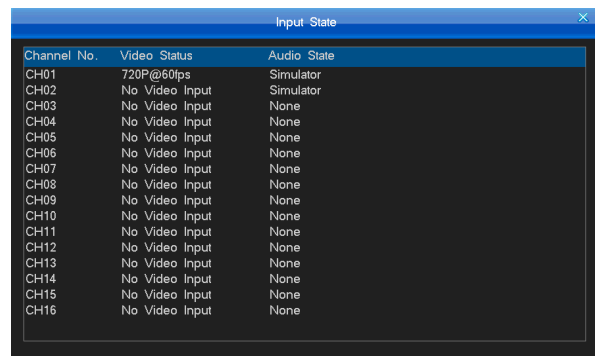
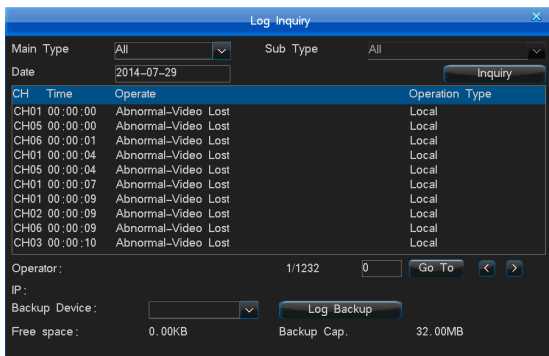

4.9.6 Input State

The input state interface will display the audio/video input source of each channel, the interface as the right picture top:



4.10 System Maintenance

Open “Main Menu” -> “System Maintenance” to quick set and manage users etc., the interface is as the right figure:

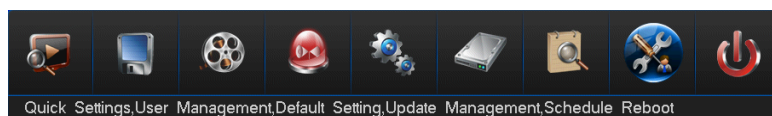

4.10.1 Quick Settings

You can quick set “Time setting”, “Network setting”, “HDD management”, “Record parameter” and so on operations, please refer to “4.2 power on wizard”.
注意: Please click “Save” button to save your parameter setting.

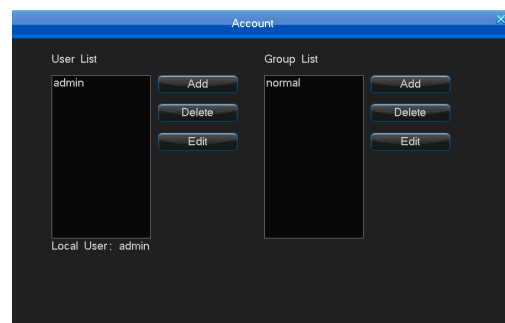
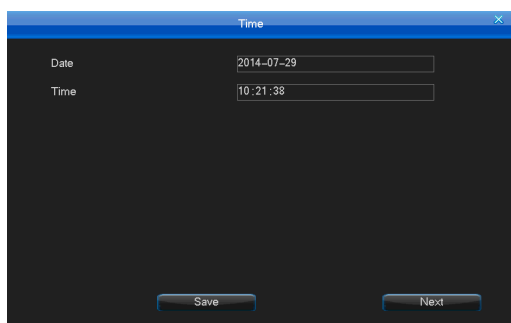

4.10.2 User Management

When the DVR leaves the factory, there is just one user named “admin”, the default has the most powerful right of all the users, and can create 14 users at most, all the rights of administrator should modify the password on the “Accounts” interface, the interface as the right picture top:

|||| User Manual

1. User Management

- Add/delete user: Focus the cursor on the “Add” icon and click to add new user, move the cursor to select the user in the user list, then focus the cursor on the “Delete” icon and click to delete the user.
- Modify password: Using the direction key of the remote controller to move the cursor to the user list, press “OK”, then you can get in the interface, or click the mouse to get in.
- Support local and remote rights setting.

2. User Group

Support user group function: each user can just take part in one group, the admin user can distribute rights to users in this group. The interface is as follows.

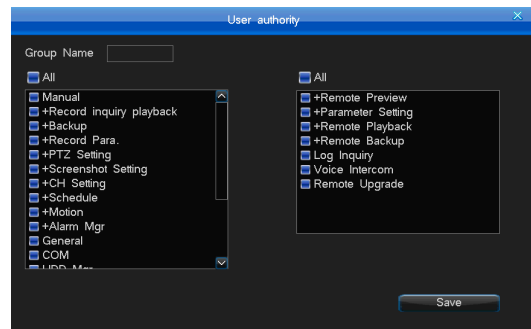
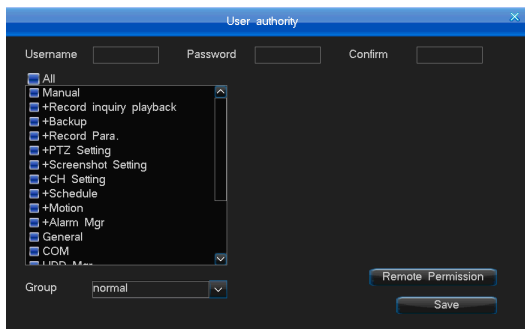

4.10.3 Restore Defaults

The way to restore default setting: After login, through “System Maintenance” -> “Restore Defaults” continuous operations to enter the interface, as the right picture below:

หมายเหตุ: Network IP and port, System time, user account and hard disk management wouldn't be restore default when do this operation.

System default parameters:

General: Enable auto-lock (enable), Auto lock (3 minutes); Open remote control lock (disable); Host id (1), Display power on wizard (enable).

Output: Video area mask (disable); Special region (disable); Channel name position; Display time (enable); Date format (YYYY-MM-DD); Display channel name (Enable);

Display temperature (Enabled); Channel Sequence (Disable).



Encode Para.: Record mode (All); Encoding stream type (VBR); Definition (1080p/720p); Bitrate (4M); Image quality (High); Frame rate (25/30/50/60 fps); Audio (Enabled); Audio type (digital audio); pre-record time (10s); Alarm Delay-record time (30s); Enable schedule snapshot (Disable); Enable motion snapshot (Disable); Enable alarm snapshot (Disable); Snapshot period (1S); Snapshot number (1 pcs).

Schedule record: Schedule record (Disable).

Alarm Setting: Motion record (Disable); Alarm record (Disable); Sensor type (Normal On); Alarm output channel (4); PTZ preset point (Disable); Email linkage (Disable) Network: Obtain IP address automatically (on); UPNP (on); DDNS (on. *หมายเหตุ*: only the servers that register automatically); auto redial (Disable); Network bitrate (512K); Image quality (High); Network audio (Enable).

Schedule Restart: Schedule restart (Disable).

COM: COM device (PTZ); Baudrate (9600); Data bit (8); Parity bit (None); Stop bit (1).

PTZ: PTZ Protocol (Unknown); Address code (the same with channel number).

- Reset defaults: Click “Reset defaults” button and confirm, then select the options above parameters revert to the factory defaulted parameters.

- Restore factory settings: The machine will reboot automatically after you click the “Reset factory setting” button and confirm it. All the parameters (not including network IP address) are stored to the factory defaulted parameters.

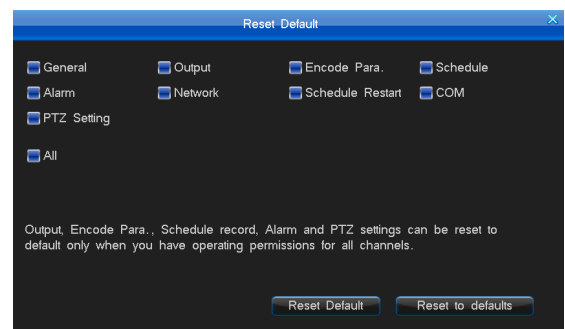

4.10.4 Upgrade Management

There has 3 kinds of upgrade method: 1.Web netview upgrade 2.USB upgrade 3.FTP upgrade

Please read the upgrade instructions carefully before upgrade.

1. Web netview upgrade

- Please double check the version of the upgrade software, so you can restore to the former version when your upgrade is failed. If your system are running well or just don't need the new function, we recommend you keep the default version. Please backup the important record files before upgrade.
- Do ensure supplying the power and the stability of network when upgrading. Network outages and interrupted power supply will cause upgrading failure. If the host-side did not appear “the update was successful, which is resuming the equipment, please be later...” in 5 minutes after the browser side shows uploading upgrade file completed, you can shut down and then reboot, then check whether the host computer update was successful.
- Please double check the version of the upgrade software, including machine model and boot interface, and make sure whether it corresponds to your system. If you have any doubts, don't upgrade, or in case you fail to upgrade the firmware, you can neither redo the system upgrade nor restart the machine (These upgrade failure machine must send back to the factory).
- After upgrade, for the new features, please refer to the user manual of the new version. You can get the new version from our website or the suppliers.
- Please don't modify the software (including the name of the firmware), otherwise, we will take no responsibility and will not provide free update.

|||| User Manual

➤ The procedure is as follows:

1. Connect the Net DVR to PC by coherent network cable or LAN (pay attention to IP conflict).
2. Before upgrading, please confirm the IP address of host computer, input http://host IP:http port in browser address, download the webcontrol.exe and install then login.
3. After login then choose “Config” -> “Remote upgrade” to open upgrade interface.
4. Click “Browse” button to choose the file to be updated, and refer to the following figure.
5. The following figure is displayed on DVR.
6. Waits for 3 seconds, the DVR will display “Network upgrading...”. It probably takes 1-3 minutes to update the software.
7. The “System is rebooting, please wait...” message will show in DVR when firmware upgrade succeed. Then the machine will automatically restart.
8. The DVR administrator password will not change after upgrading.

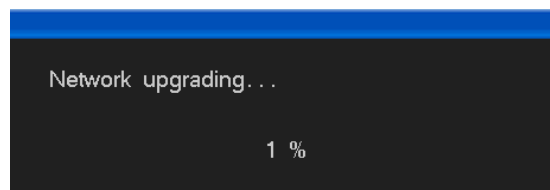
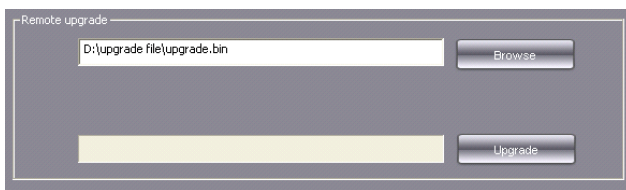

2. USB Upgrade

Operation steps:

1. Copy the upgrade.bin to the U disk.
2. Plug into the USB disk on the back of the DVR, right click the mouse, then pops out the tip, and confirm it.
3. The host says “Local upgrading...”.
4. When the upgrade have been finished, the host will pops out “Local upgrade was successful!”, that indicates the upgrade is successful, then the host will restart automatically.
5. The DVR administrator password will not change after upgrading.

3. FTP upgrade

Operation steps:

1. Open the FTP server software, configure it follow the setup wizard. Create user name and password in server. Set the root directory (the folder which will place upgrade file), set the permission (must set the download permission).
2. Enter server after configuration. Set the FTP server IP and port.
3. Start FTP service.
4. Click “System Maintenance” -> “Upgrade Management” -> “FTP upgrade”, set the DVR information as below:

Username = the username which create in step1.

Password = the password which create in step1.

Port = the server port which set in step2.

Server address = the server IP which set in step2.

File path = the location where you place the upgrade file. If you set the D:\ as the root directory, then the upgrade.bin directory is D:\90XX\upgrade.bin, so the file path is\90XX\upgrade.bin, then save, click “FTP upgrade” to upgrade host.

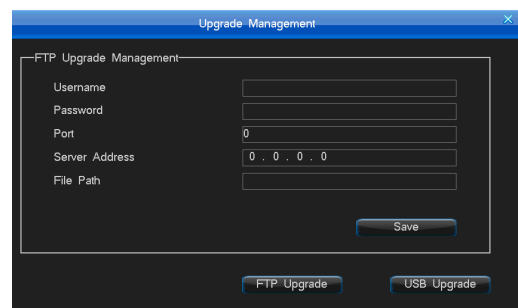

4.10.5 Auto Reboot

Choose “Main menu” -> “System Maintenance” -> “Auto Reboot” to enter the interface, the interface is as the right bottom picture:

Enable the system auto-restart function, set restart time then save. When the DVR host time reach the set time, it will shows “Schedule time out, whether restart at once?”. Choose “Yes” to confirm restart and choose “Cancel” to cancel restart. If you do no choice, the system will auto-restart after 20 seconds.

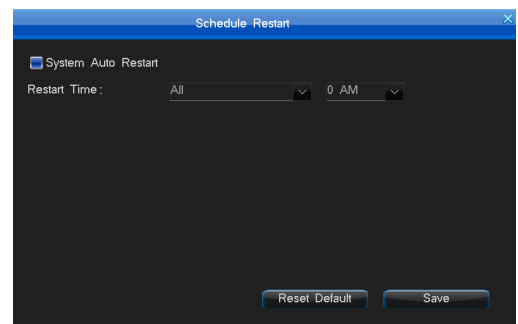

|||| User Manual

4.11 Logout/Shutdown/Reboot

To do Logout User, Shutdown, Restart operations by "Main Menu" -> "Shutdown" menu as right picture:

- Logout: Device will auto-lock after logout.
- Shutdown: After you shutdown here, please click the power button in front panel to start up DVR.

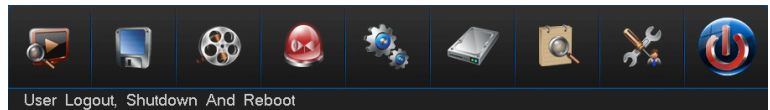

4.12 Password Reset

When user forget the DVR host administrator password, please recover password by following steps:

1. Shutdown DVR host. Cut off the power supply.
2. Remove the cover screws to open the case cover.
3. Find the J1 contact pin on top right of the back of front panel.
4. Set the 1, 2 pin of J1 contact pin to short-circuit by jumper block. (The jumper cap default in 2, 3 foot when leave factory).
5. Turn on the power to start the host, the front panel buzzer will beep, indicating that the password has been cleared to the factory defaults.
6. Shutdown the host and cut off power supply again.
7. Unplug the jumper block, set the 1, 2 pin of J1 contact pin to open-circuit, and place jumper block to J1 contact pin.
8. Fixed on the chassis cover, password reset is complete.

4.13 Power Resume

When system is in standby or running state, if system was cut off power supply abnormally, after the power supply recovered, the system will auto-start up and recover to the working state before power supply cut off. It can make the system work continuous when system may loss power supply.

Appendix 1 IE Operation Instructions

Notice: Please set firewall rank for low or medium, and surf software or net assistant software, etc. should be blocked or unloaded, otherwise the software may not run properly. Please guarantee to install DirectX 9.0 of Microsoft and confirm the Internet Explorer edition is 6.0 version or above. All hardware driver version should upgrade to the latest.

1. LAN Configuration for IE Browse

Step1: "Ping" the host IP first to confirm if the DVR is connected, the interface is as "Figure 1".

Step2: Type the host IP into windows IE and connect to the DVR. Input the address of the host to access the equipment in the IE browser (<http://device host IP:81>), and then enter to connect, after a successful connection click "Download" button to download, and running control. Refresh the browser, enter your user name and password to login in the login box. If login is successful, the interface will pop up as "Figure 2".

Step3: Please refer to "Client user guide" for further operation.

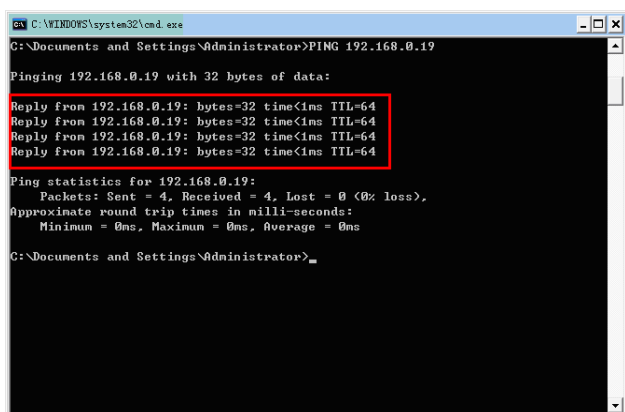

Figure 1

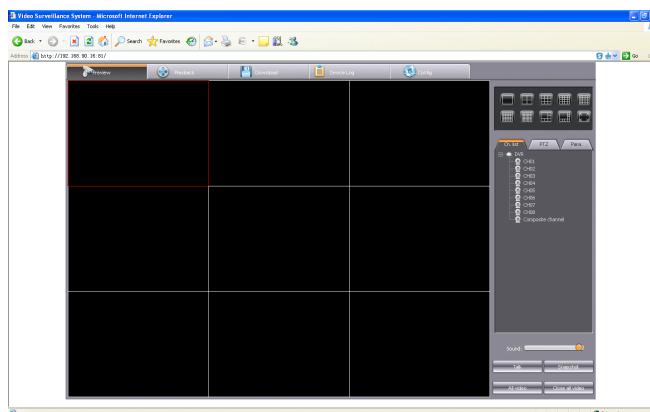

Figure 2

|||| User Manual

2. WAN Operation Instructions

Step1: If there are fixed WAN IP address which could be given to the host DVR, you could connect DVR to WAN directly, set IP, subnet mask and gateway, then access normally.

Step2: Connecting to WAN through PPPOE dialing.

Step3: Access through the router forwarding.

(When forwarding, the gateway should be set as current forwarding server. 转发设置: forwarding instruction is for TCP protocol)

IE access format: http://WAN IP:http port; http://Domain name:http port.

Introduction of forwarding through router:

转发设置: In the "Figure 4", the default values of command port and HTTP port is 8101 and 81. User could set these 2 default values in customized and save.

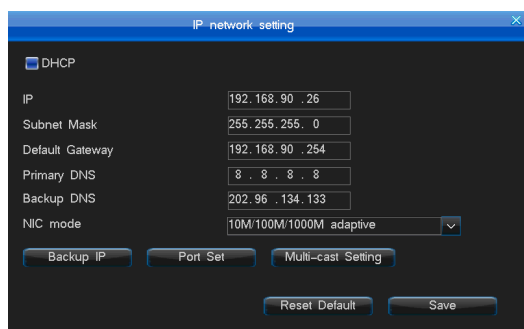

Figure3

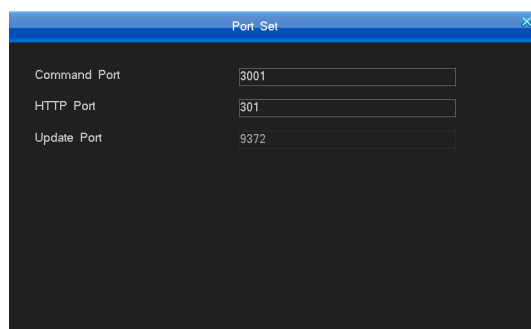

Figure4



If you connect by static IP, you need set port mapping in your router.
Take TP-LINK TL-480T model router for example:

[1] After signing up routers, by choosing “Running Status” icon on left side menu of Figure 5, view the LAN IP and WAN IP address of the routers, such as, the LAN IP address 192.168.2.1, WAN IP address 116.30.143.163.

WAN

WAN Port: WAN1
WAN Connection Type: L2TP

User Name: username
Password: *****
Connect Disconnect Disconnected!

Dynamic IP Static IP

Server IP Address Name:
IP Address: 192.168.2.1
Subnet Mask: 0.0.0.0
Gateway: 0.0.0.0
DNS: 0.0.0.0, 0.0.0.0

Internet IP Address: 116.30.143.163
Internet DNS: 0.0.0.0, 0.0.0.0

MTU Size (in bytes): 1452 (The default is 1460, do not change unless necessary)
Max Idle Time: 15 minutes (0 means remain active at all times.)

WAN Connection Mode: Connect on Demand
 Connect Automatically
 Connect Manually

Save

Figure5

[2] Select “Transfer Rules” on Figure 5 left menu, click “Add new” button to add new port mapping items on Figure 6 menu. You should both mapping http port (81) and command port (8101) at the same time. And each port mapping should both include TCP/UDP (ALL) protocol. Click “Save” button to save the settings.

Virtual Servers

ID	Service Port	IP Address	Protocol	Status	Modify
1	8101	192.168.2.6	ALL	Enabled	Modify Delete
2	81	192.168.2.6	ALL	Enabled	Modify Delete

Add New... Enable All Disable All Delete All

Previous Next

Figure6

||| User Manual

[3] Port Description: The command port is the TCP port of all DVRs communications, and HTTP port is IE browser port.

Input the address like: `http://116.30.143.163:http port`. After a successful connection click "Download" button to download, and running control. Refresh the browser, then enter your user name and password to login in the login box (Figure 7). If login is successful, the interface will pop up as "Figure 8".

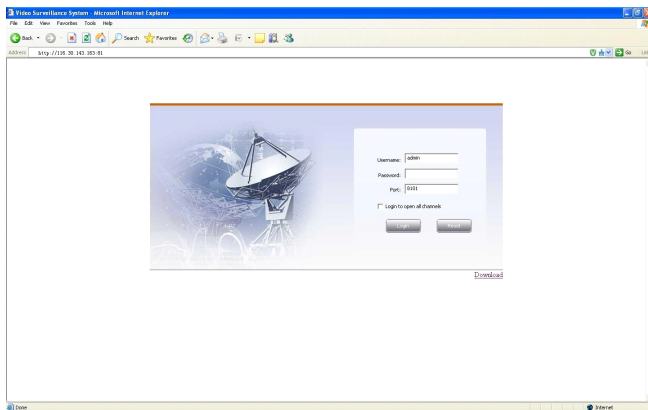

Figure 7

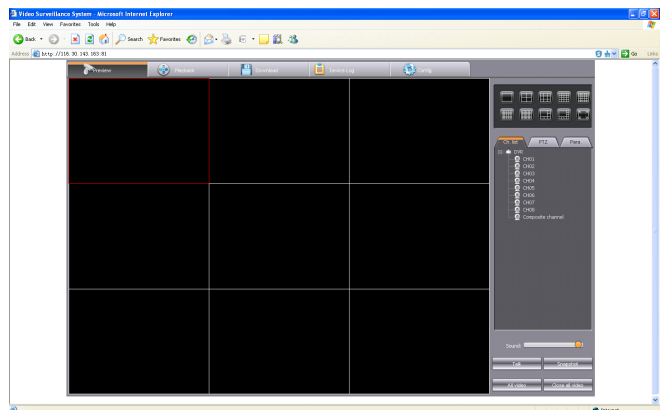

Figure 8

Appendix 2: Net DVR Q&A

Thank you for choosing our DVR series products. We will always be at your services. In case you have any difficulty while using the products, please refer to the below frequently asked questions & answers. If you cannot find solution here, or the solution offered here still fails, please feel free to contact us by our hotline and/or technical support E-mail box. We will make most timely reply to your questions.

Testing Methods:

- [1] Replace Method (Replace the power supply and HDD of the DVR).
- [2] Minimum Load Method (Get rid of the HDD, video, audio and alarm resource).
- [3] Upgrade (Solve some incompatible problems).

หมายเหตุ: Some problems may be caused by incorrect operation. If you can not make sure the problems, please run "Reset to default" option.



(A) The problem about rebooting, self testing, system halted.



01: Why the DVR doesn't start up though power cable is well connected to power source?



01: 1. Check if you have turned on the switcher on the back panel. 2. Check if you have inputted the right power password and pressed Enter button.



02: I see the Super DVR logo, but why it stops at self-check process?



02: To detect if the problem is caused by hard disks, please remove all the hard disks and start system again. The DVR can start up without a hard disk. After start up, system will prompt "system does not detect the disk information, whether to continue". Click "OK" button, and the host can engage in normal operation.





03: My system can finally start up but seems to be quite slow. Why?





03: Hard disk error will take system much time on rechecking.

|||| User Manual

 04: Why does my system restart after self-check?

 04: 1.Check the hard disks if they are in FAT32 file format, if not, change to FAT32. 2.Check Color System setting in Record Parameter menu. In case this setting is PAL, while present video input is in NTSC format, which will cause system restart. 3.Please unplug the network cable, to see whether DVRs run normally, since there are serious problems of the network which may also cause the host to restart repeatedly.

 05: Why my remoter doesn't work?

 05: 1.Please check if the IR indicator light on the front panel flashes when you make operations with the buttons. If not, please check whether the remote control has run out of battery, or the remote control has been damaged. 2.Check if the front panel is in lock up status. If so, press Login/Lock button and input power password to unlock. 3.Please check if the host software locks the operation. If yes, please input user name, password to login, so to make IR remoter control work.

 06: Why system halts at some certain time?

 06: In case system halts at some certain time, for example, around 7:30am, please check your electricity system. This problem is mostly happened in factories, when at around 7:30, all machines start and cause power supply in a short temporarily. Try to make the DVR not connect to the same circuit as the industrial machines.



(B) Display Problems

 01: Why there is nothing displayed on the monitor or the display keeps shaking?

 01: 1.Check if the power is on or not. If the power is on, the power light at the front panel should be on. 2.Check the display mode. It can display VGA/CVBS/HDMI at the same time. Please check if you have connected video input. If not, VGA/CVBS/HDMI will all displaying nothing.

 02: Why my DVR display images that seems to be interfered, and like water wave shape?

 02: 1.Please check if the video cable has well connected. 2.Check if there are strong electricity current around the video cable. Please don't put video cable together with electricity cables to avoid interfering. 3.Please check if the DVR case is well grounded. Only connect the case to ground by the screw on the back panel, while no other points connect to ground. 4.Please check camera, monitor and video cables if they are aging.



- ?** 03: Why both the live display image and playback image are not showing the true color?
👉 03: Please check if you have set the parameters well. (Please refer to chapter 4.7.3 for details)
- ?** 04: Why my DVR displays distorted images on VGA monitor or cannot make full screen display?
👉 04: 1.Please check if your VGA monitor is well set up. 2.Change your VGA monitor settings till make it full screen.
- ?** 05: Why my DVR system shows disordered color?
👉 05: 1.Please check you VGA data line, as well as connection condition between DVR to VGA monitor.
2.Check if the DVR system has overheat.
- ?** 06: I started my system seeming to be successfull, but there was a certain channel displaying nothing, neither caption. Why?
👉 06: Please make restore to factory default settings.
- ?** 07: Why it displays mosaics when playback?
👉 07: 1.Check the recording parameter setting. If the recording parameter is set too low, it can influence the image quality and cause mosaics.
2.If bad sectors exist in the HDD, it might cause mosaics when playback. Users need to check HDD.